

Bearing No. 21313 E

b	6 mm
K	3 mm
d	65 mm
D	140 mm
B	33 mm
Noun	Bearing
Bore	2.559 Inch 65 Millimeter
Width	1.299 Inch 33 Millimeter
UNSPSC	31171510
series:	213
Category	Spherical Roller Bearing
Size (mm)	140x65x33
Enclosure	Open
Inventory	0.0
bore type:	Straight
Width (mm)	33
cage type:	Inner Ring Guided
maximum rpm:	6000 RPM
Weight / LBS	5.671
Bore Profile	Straight
Mass bearing	2.55 kg
D1	124 mm
Cage Material	Steel
closure type:	Open
d2	94.7 mm
Product Group	B04311
Inch - Metric	Metric
fillet radius:	2 mm

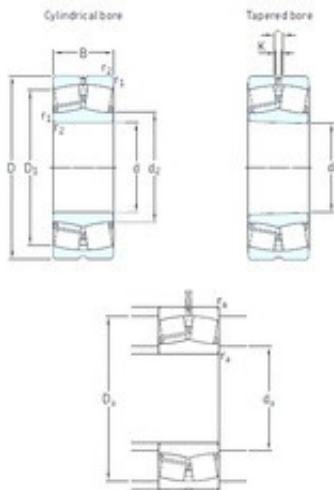

Bearing No. 21312E

C	31 mm
B	31 mm
K	3 mm
b	6 mm
d	60 mm
D	130 mm
d2	87,8 mm
D1	115 mm
Weight	2,1 Kg
ra max.	2 mm
r1 min.	2,1 mm
r2 min.	2,1 mm
da min.	72 mm
Da max.	118 mm
Size (mm)	60x130x31
Width (mm)	31
Limiting speed	6300 r/min
Bearing number	21312E
Reference speed	4800 r/min
Bore Diameter (mm)	60
Outer Diameter (mm)	130
Calculation factor (e)	0,22
Fatigue load limit (Pu)	26,5
Calculation factor (Y0)	2,8
Calculation factor (Y1)	3
Basic dynamic load rating (C)	212 kN
Basic static load rating (C0)	240 kN

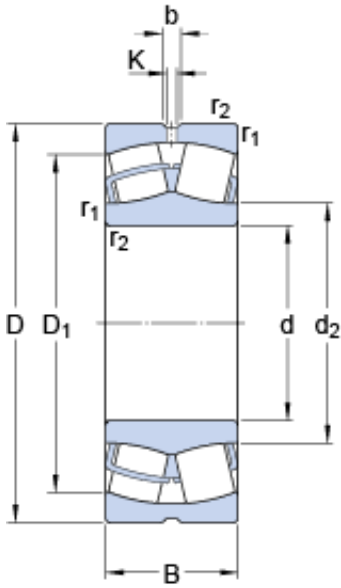

Bearing No. 21311 E

b	6 mm
K	3 mm
d	55 mm
D	120 mm
B	29 mm
Noun	Bearing
Bore	2.165 Inch 55 Millimeter
Width	1.142 Inch 29 Millimeter
UNSPSC	31171510
series:	213
Category	Spherical Roller Bearing
Size (mm)	120x55x29
Enclosure	Open
Inventory	8.0
bore type:	Straight
Width (mm)	29
cage type:	Inner Ring Guided
maximum rpm:	7500 RPM
Weight / LBS	3.761
Bore Profile	Straight
Mass bearing	1.7 kg
D1	96.2 mm
Cage Material	Steel
closure type:	Open
d2	72.7 mm
Product Group	B04311
Inch - Metric	Metric
fillet radius:	2 mm

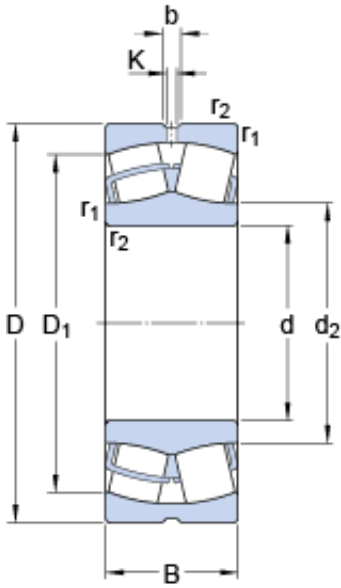

Bearing No. 21310 E

b	6 mm
K	3 mm
d	50 mm
D	110 mm
B	27 mm
Noun	Bearing
Bore	1.969 Inch 50 Millimeter
Width	1.063 Inch 27 Millimeter
UNSPSC	31171510
series:	213
Category	Spherical Roller Bearing
Size (mm)	110x50x27
Enclosure	Open
Inventory	1.0
bore type:	Straight
Width (mm)	27
cage type:	Inner Ring Guided
maximum rpm:	7500 RPM
Weight / LBS	2.899
Bore Profile	Straight
Mass bearing	1.35 kg
D1	96.8 mm
Cage Material	Steel
closure type:	Open
d2	72.7 mm
Product Group	B04311
Inch - Metric	Metric
fillet radius:	2 mm

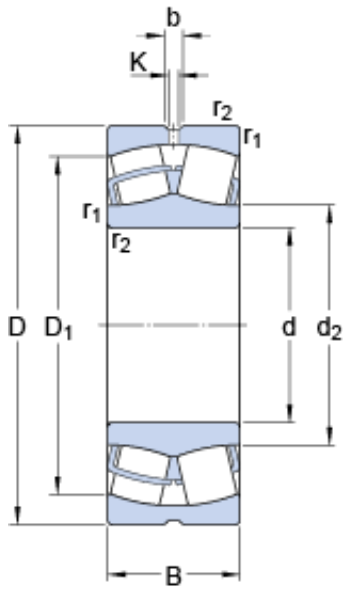

Bearing No. 21309 E

b	6 mm
K	3 mm
d	45 mm
D	100 mm
B	25 mm
Noun	Bearing
Bore	1.772 Inch 45 Millimeter
Width	0.984 Inch 25 Millimeter
UNSPSC	31171510
series:	213
Category	Spherical Roller Bearing
Size (mm)	100x45x25
Enclosure	Open
Inventory	1.0
bore type:	Straight
Width (mm)	25
cage type:	Inner Ring Guided
maximum rpm:	8500 RPM
Weight / LBS	2.22
Bore Profile	Straight
Mass bearing	0.99 kg
D1	88 mm
Cage Material	Steel
closure type:	Open
d2	65.3 mm
Product Group	B04311
Inch - Metric	Metric
fillet radius:	1.5 mm

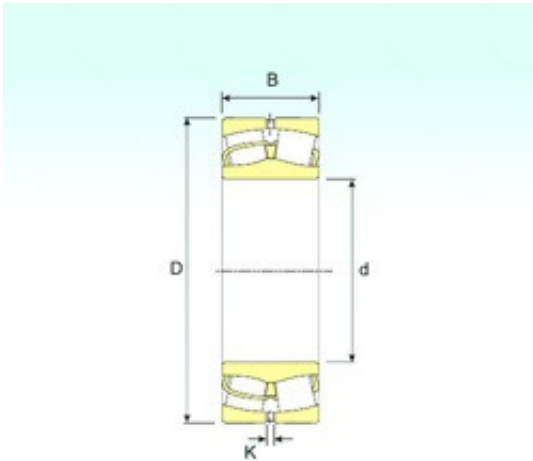

Bearing No. 21308

D	90 mm
d	40 mm
B	23 mm
C	23 mm
K	3 mm
Weight	0,75 Kg
Size (mm)	40x90x23
Width (mm)	23
Bearing number	21308
Bore Diameter (mm)	40
Outer Diameter (mm)	90
(Grease) Lubrication Speed	7267,5 r/min
Basic dynamic load rating (C)	102 kN
Basic static load rating (C0)	106 kN

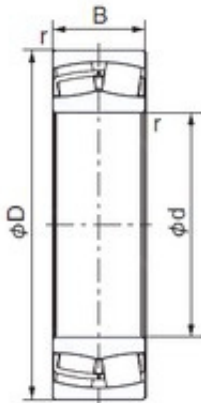

Bearing No. 21307E

D	80 mm
d	35 mm
B	21 mm
C	21 mm
r min.	1,5 mm
Weight	0,57 Kg
Category	Bearings
Size (mm)	35x80x21
Inventory	0.0
Width (mm)	21
Product Group	B04311
Bearing number	21307E
Weight / Kilogram	0
Manufacturer Name	NACHI
Bore Diameter (mm)	35
Outer Diameter (mm)	80
Minimum Buy Quantity	N/A
Calculation factor (e)	0,27
(Oil) Lubrication Speed	8500 r/min
Calculation factor (Y0)	2,43
Calculation factor (Y1)	2,49
(Grease) Lubrication Speed	7000 r/min
Basic dynamic load rating (C)	96 kN
Basic static load rating (C0)	76 kN

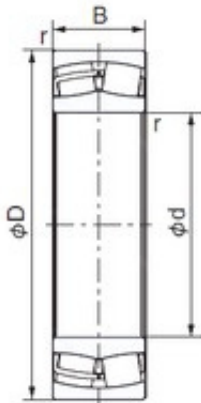

Bearing No. 21306E

D	72 mm
d	30 mm
B	19 mm
C	19 mm
r min.	1,1 mm
Weight	0,43 Kg
Category	Bearings
Size (mm)	30x72x19
Inventory	0.0
Width (mm)	19
Product Group	B04311
Bearing number	21306E
Weight / Kilogram	0
Manufacturer Name	NACHI
Bore Diameter (mm)	30
Outer Diameter (mm)	72
Minimum Buy Quantity	N/A
Calculation factor (e)	0,27
(Oil) Lubrication Speed	9500 r/min
Calculation factor (Y0)	2,43
Calculation factor (Y1)	2,49
(Grease) Lubrication Speed	8000 r/min
Basic dynamic load rating (C)	83 kN
Basic static load rating (C0)	62,5 kN

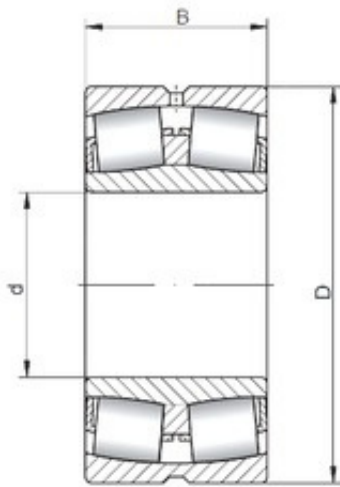

Bearing No. 21304

D	52 mm
d	20 mm
B	15 mm
C	15 mm
Size (mm)	20x52x15
Width (mm)	15
Bearing number	21304
Bore Diameter (mm)	20
Outer Diameter (mm)	52

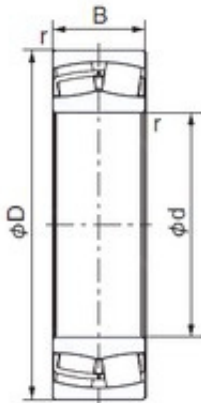

Bearing No. 21305E

C	17 mm
d	25 mm
D	62 mm
B	17 mm
r min.	1,1 mm
Weight	0,29 Kg
Size (mm)	25x62x17
Width (mm)	17
Bearing number	21305E
Bore Diameter (mm)	25
Outer Diameter (mm)	62
Calculation factor (e)	0,28
(Oil) Lubrication Speed	11500 r/min
Calculation factor (Y0)	2,34
Calculation factor (Y1)	2,39
(Grease) Lubrication Speed	9000 r/min
Basic dynamic load rating (C)	64 kN
Basic static load rating (C0)	47,5 kN

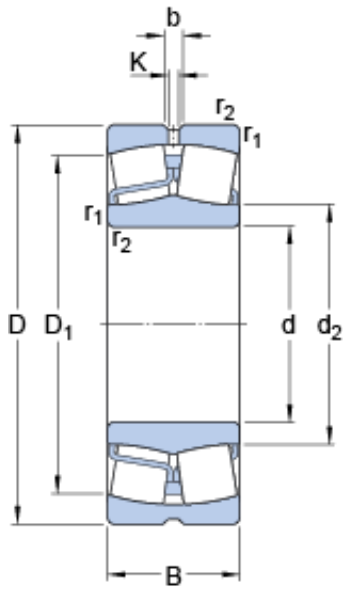

Bearing No. 22214 E

b	6 mm
K	3 mm
d	70 mm
D	125 mm
B	31 mm
Bore	2.756 Inch 70 Millimeter
Noun	Bearing
Width	1.22 Inch 31 Millimeter
UNSPSC	31171510
series:	222
Category	Spherical Roller Bearing
Size (mm)	125x70x31
Enclosure	Open
Inventory	0.0
Width (mm)	31
bore type:	Straight
maximum rpm:	6700 RPM
Weight / LBS	3.637
Bore Profile	Straight
Mass bearing	1.55 kg
Cage Material	Steel
closure type:	Open
d2	83 mm
D1	111 mm
Inch - Metric	Metric
Product Group	B04311
Limiting speed	6700 r/min
fillet radius:	1.5 mm
cage material:	Steel

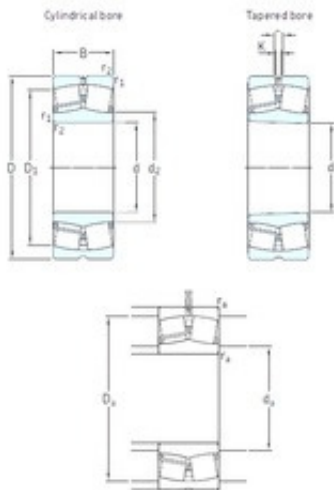

Bearing No. 22213E

C	31 mm
B	31 mm
K	3 mm
b	6 mm
d	65 mm
D	120 mm
d2	80,1 mm
D1	106 mm
Weight	1,55 Kg
ra max.	1,5 mm
r1 min.	1,5 mm
r2 min.	1,5 mm
da min.	74 mm
Da max.	111 mm
Size (mm)	65x120x31
Width (mm)	31
Limiting speed	7000 r/min
Bearing number	22213E
Reference speed	5000 r/min
Bore Diameter (mm)	65
Outer Diameter (mm)	120
Calculation factor (e)	0,24
Fatigue load limit (Pu)	24
Calculation factor (Y0)	2,8
Calculation factor (Y1)	2,8
Basic dynamic load rating (C)	193 kN
Basic static load rating (C0)	216 kN

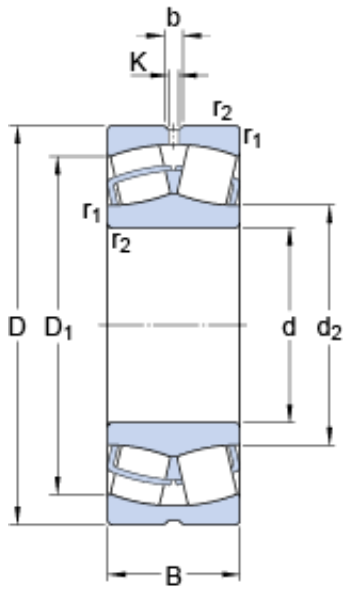

Bearing No. 22212 E

b	6 mm
K	3 mm
d	60 mm
D	110 mm
B	28 mm
Noun	Bearing
Bore	2.362 Inch 60 Millimeter
Width	1.102 Inch 28 Millimeter
UNSPSC	31171510
series:	222
Category	Spherical Roller Bearing
Size (mm)	110x60x28
Enclosure	Open
Inventory	0.0
bore type:	Straight
Width (mm)	28
cage type:	Inner Ring Guided
maximum rpm:	7500 RPM
Weight / LBS	2.586
Bore Profile	Straight
Mass bearing	1.15 kg
D1	96.5 mm
Cage Material	Steel
closure type:	Open
d2	72.7 mm
Product Group	B04311
Inch - Metric	Metric
fillet radius:	1.5 mm

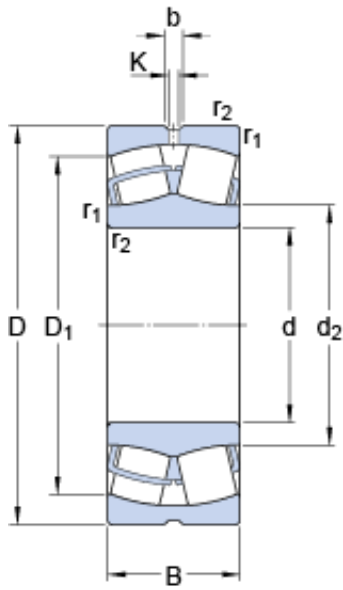

Bearing No. 22211 E

b	6 mm
K	3 mm
d	55 mm
D	100 mm
B	25 mm
Noun	Bearing
Bore	2.165 Inch 55 Millimeter
Width	0.984 Inch 25 Millimeter
UNSPSC	31171510
series:	222
Category	Spherical Roller Bearing
Size (mm)	100x55x25
Enclosure	Open
Inventory	0.0
bore type:	Straight
Width (mm)	25
cage type:	Inner Ring Guided
maximum rpm:	8500 RPM
Weight / LBS	1.875
Bore Profile	Straight
Mass bearing	0.84 kg
D1	88 mm
Cage Material	Steel
closure type:	Open
d2	65.3 mm
Product Group	B04311
Inch - Metric	Metric
fillet radius:	1.5 mm

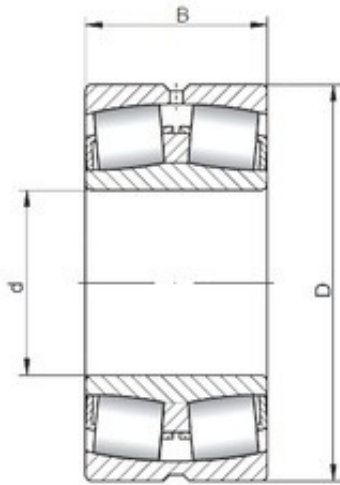

Bearing No. 22210W33

D	90 mm
d	50 mm
B	23 mm
C	23 mm
Size (mm)	50x90x23
Width (mm)	23
Bearing number	22210W33
Bore Diameter (mm)	50
Outer Diameter (mm)	90

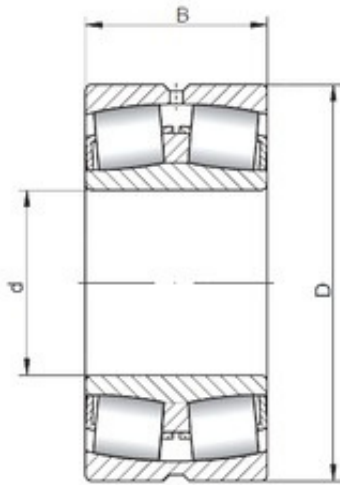

Bearing No. 22209W33

D	85 mm
d	45 mm
B	23 mm
C	23 mm
Size (mm)	45x85x23
Width (mm)	23
Bearing number	22209W33
Bore Diameter (mm)	45
Outer Diameter (mm)	85

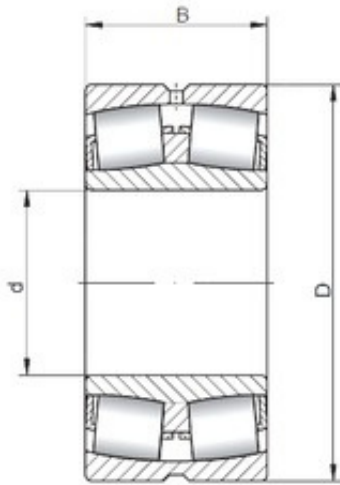

Bearing No. 22207W33

D	72 mm
d	35 mm
B	23 mm
C	23 mm
Size (mm)	35x72x23
Width (mm)	23
Bearing number	22207W33
Bore Diameter (mm)	35
Outer Diameter (mm)	72

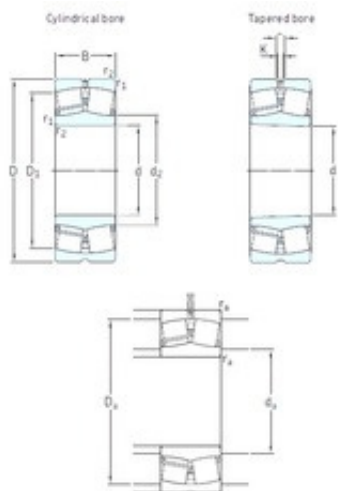

Bearing No. 22208E

C	23 mm
B	23 mm
K	3 mm
b	6 mm
d	40 mm
D	80 mm
d2	49,6 mm
D1	69,4 mm
Weight	0,53 Kg
ra max.	1 mm
r1 min.	1,1 mm
r2 min.	1,1 mm
da min.	47 mm
Da max.	73 mm
Size (mm)	40x80x23
Width (mm)	23
Limiting speed	11000 r/min
Bearing number	22208E
Reference speed	8000 r/min
Bore Diameter (mm)	40
Outer Diameter (mm)	80
Calculation factor (e)	0,28
Fatigue load limit (Pu)	9,8
Calculation factor (Y0)	2,5
Calculation factor (Y1)	2,4
Basic dynamic load rating (C)	96,5 kN
Basic static load rating (C0)	90 kN

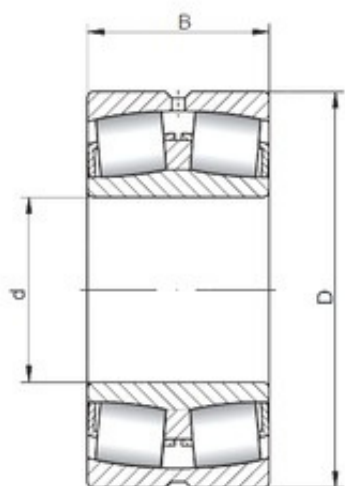

Bearing No. 22206W33

D	62 mm
d	30 mm
B	20 mm
C	20 mm
Size (mm)	30x62x20
Width (mm)	20
Bearing number	22206W33
Bore Diameter (mm)	30
Outer Diameter (mm)	62

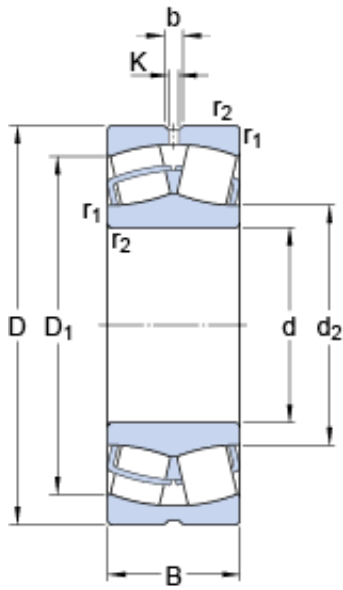

Bearing No. 22205 E

b	3.7 mm
K	2 mm
d	25 mm
D	52 mm
B	18 mm
Noun	Bearing
Bore	0.984 Inch 25 Millimeter
Width	0.709 Inch 18 Millimeter
UNSPSC	31171510
series:	222
Category	Spherical Roller Bearing
Size (mm)	52x25x18
Enclosure	Open
Inventory	0.0
bore type:	Straight
Width (mm)	18
cage type:	Inner Ring Guided
maximum rpm:	17000 RPM
Weight / LBS	0.408
Bore Profile	Straight
Mass bearing	0.26 kg
D1	44.2 mm
Cage Material	Steel
closure type:	Open
d2	31.3 mm
Product Group	B04311
Inch - Metric	Metric
fillet radius:	1 mm

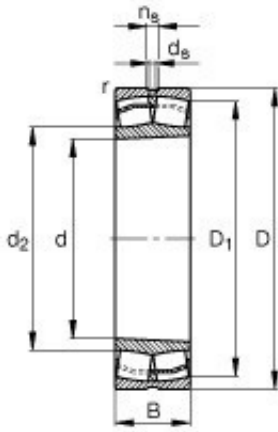

Bearing No. 22317-E1-K-T41A

m	7,1 kg / Weight
d	85 mm
D	180 mm
B	60 mm
e	0,33
Size (mm)	85x180x60
Width (mm)	60
nB	3300 1/min
nG	4100 1/min / Limiting speed
Y0	2
Y2	3,04
Y1	2,04
Cr	540000 N / Dynamic load rating (radial)
ds	4,8 mm
ns	9,5 mm
d2	104,4 mm
D1	154,2 mm
C0r	560000 N / Static load rating (radial)
Bearing number	22317-E1-K-T41A
rmin	3 mm
ra max	2,5 mm
da min	99 mm
Da max	166 mm
Bore Diameter (mm)	85
Outer Diameter (mm)	180

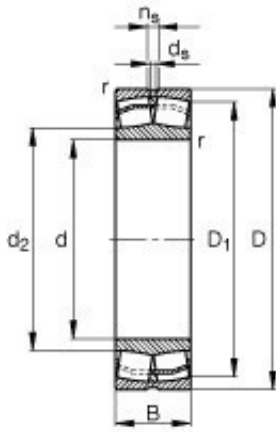

Bearing No. 22316-E1-T41A

m	6,27 kg / Weight
d	80 mm
D	170 mm
B	58 mm
e	0,34
Size (mm)	80x170x58
Width (mm)	58
nB	3450 1/min
nG	4250 1/min / Limiting speed
Y0	1,94
Y2	2,96
Y1	1,99
Cr	495000 N / Dynamic load rating (radial)
ds	4,8 mm
ns	9,5 mm
d2	98,3 mm
D1	145,1 mm
C0r	510000 N / Static load rating (radial)
Bearing number	22316-E1-T41A
rmin	2,1 mm
ra max	2,1 mm
da min	92 mm
Da max	158 mm
Bore Diameter (mm)	80
Outer Diameter (mm)	170

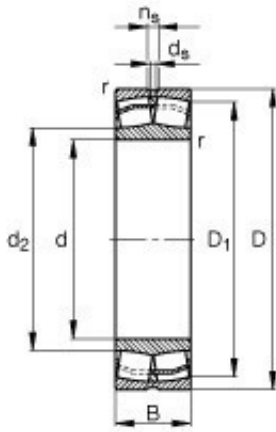

Bearing No. 22315-E1-T41A

m	5,38 kg / Weight
d	75 mm
D	160 mm
B	55 mm
e	0,34
Size (mm)	75x160x55
Width (mm)	55
nB	3650 1/min
nG	4500 1/min / Limiting speed
Y0	1,94
Y2	2,96
Y1	1,99
Cr	445000 N / Dynamic load rating (radial)
ds	4,8 mm
ns	9,5 mm
d2	92,4 mm
D1	136,3 mm
C0r	450000 N / Static load rating (radial)
Bearing number	22315-E1-T41A
rmin	2,1 mm
ra max	2,1 mm
da min	87 mm
Da max	148 mm
Bore Diameter (mm)	75
Outer Diameter (mm)	160

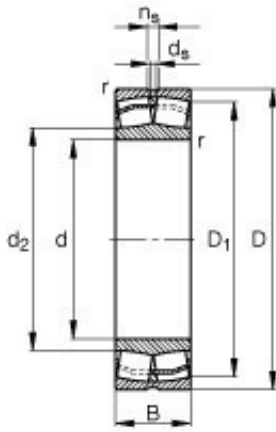

Bearing No. 22314-E1-T41A

m	4,21 kg / Weight
d	70 mm
D	150 mm
B	51 mm
e	0,34
Size (mm)	70x150x51
Width (mm)	51
nB	3850 1/min
nG	4800 1/min / Limiting speed
Y0	1,96
Y2	2,98
Y1	2
Cr	390000 N / Dynamic load rating (radial)
ds	4,8 mm
ns	9,5 mm
d2	86,7 mm
D1	128 mm
C0r	390000 N / Static load rating (radial)
Bearing number	22314-E1-T41A
rmin	2,1 mm
ra max	2,1 mm
da min	82 mm
Da max	138 mm
Bore Diameter (mm)	70
Outer Diameter (mm)	150

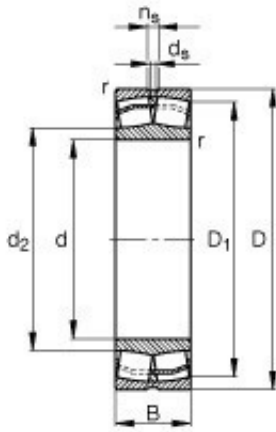

Bearing No. 22313-E1-T41A

m	3,57 kg / Weight
d	65 mm
D	140 mm
B	48 mm
e	0,34
Size (mm)	65x140x48
Width (mm)	48
nB	3950 1/min
nG	5000 1/min / Limiting speed
Y0	1,96
Y2	2,98
Y1	2
Cr	350000 N / Dynamic load rating (radial)
ds	4,8 mm
ns	9,5 mm
d2	83,2 mm
D1	119,3 mm
C0r	365000 N / Static load rating (radial)
Bearing number	22313-E1-T41A
rmin	2,1 mm
ra max	2,1 mm
da min	77 mm
Da max	128 mm
Bore Diameter (mm)	65
Outer Diameter (mm)	140

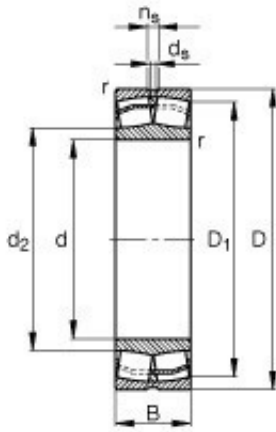

Bearing No. 22312-E1-T41A

m	2,97 kg / Weight
d	60 mm
D	130 mm
B	46 mm
e	0,35
Size (mm)	60x130x46
Width (mm)	46
nB	4300 1/min
nG	5400 1/min / Limiting speed
Y0	1,87
Y2	2,85
Y1	1,91
Cr	310000 N / Dynamic load rating (radial)
ds	3,2 mm
ns	6,5 mm
d2	74,8 mm
D1	110,1 mm
C0r	310000 N / Static load rating (radial)
Bearing number	22312-E1-T41A
rmin	2,1 mm
ra max	2,1 mm
da min	72 mm
Da max	118 mm
Bore Diameter (mm)	60
Outer Diameter (mm)	130

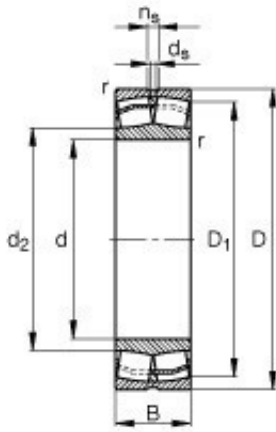

Bearing No. 22311-E1-T41A

m	2,27 kg / Weight
d	55 mm
D	120 mm
B	43 mm
e	0,36
Size (mm)	55x120x43
Width (mm)	43
nB	4650 1/min
nG	5800 1/min / Limiting speed
Y0	1,84
Y2	2,81
Y1	1,89
Cr	265000 N / Dynamic load rating (radial)
ds	3,2 mm
ns	6,5 mm
d2	68,9 mm
D1	101,4 mm
C0r	260000 N / Static load rating (radial)
Bearing number	22311-E1-T41A
rmin	2 mm
ra max	2 mm
da min	66 mm
Da max	109 mm
Bore Diameter (mm)	55
Outer Diameter (mm)	120

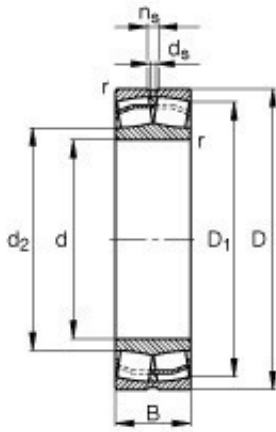

Bearing No. 22310-E1-T41A

m	1,9 kg / Weight
d	50 mm
D	110 mm
B	40 mm
e	0,36
Size (mm)	50x110x40
Width (mm)	40
nB	5000 1/min
nG	6300 1/min / Limiting speed
Y0	1,82
Y2	2,77
Y1	1,86
Cr	229000 N / Dynamic load rating (radial)
ds	3,2 mm
ns	6,5 mm
d2	63 mm
D1	92,6 mm
C0r	223000 N / Static load rating (radial)
Bearing number	22310-E1-T41A
rmin	2 mm
ra max	2 mm
da min	61 mm
Da max	99 mm
Bore Diameter (mm)	50
Outer Diameter (mm)	110

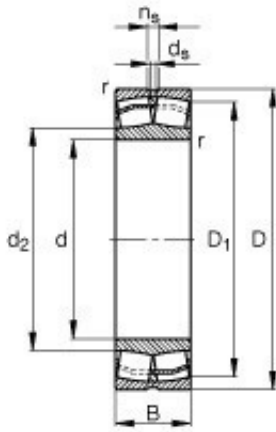

Bearing No. 22309-E1-T41A

m	1,39 kg / Weight
d	45 mm
D	100 mm
B	36 mm
e	0,36
Size (mm)	45x100x36
Width (mm)	36
nB	5300 1/min
nG	6800 1/min / Limiting speed
Y0	1,86
Y2	2,83
Y1	1,9
Cr	187000 N / Dynamic load rating (radial)
ds	3,2 mm
ns	6,5 mm
d2	58,9 mm
D1	84,7 mm
C0r	183000 N / Static load rating (radial)
Bearing number	22309-E1-T41A
rmin	1,5 mm
ra max	1,5 mm
da min	54 mm
Da max	91 mm
Bore Diameter (mm)	45
Outer Diameter (mm)	100

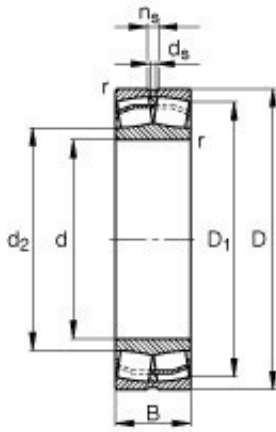

Bearing No. 22308-E1-T41A

m	1,05 kg / Weight
d	40 mm
D	90 mm
B	33 mm
e	0,36
Size (mm)	40x90x33
Width (mm)	33
nB	5800 1/min
nG	7600 1/min / Limiting speed
Y0	1,82
Y2	2,77
Y1	1,86
Cr	156000 N / Dynamic load rating (radial)
ds	3,2 mm
ns	4,8 mm
d2	52,4 mm
D1	76 mm
C0r	149000 N / Static load rating (radial)
Bearing number	22308-E1-T41A
rmin	1,5 mm
ra max	1,5 mm
da min	49 mm
Da max	81 mm
Bore Diameter (mm)	40
Outer Diameter (mm)	90

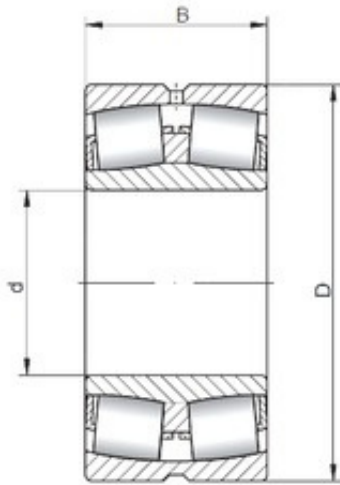

Bearing No. 22317W33

D	180 mm
d	85 mm
B	60 mm
C	60 mm
Size (mm)	85x180x60
Width (mm)	60
Bearing number	22317W33
Bore Diameter (mm)	85
Outer Diameter (mm)	180

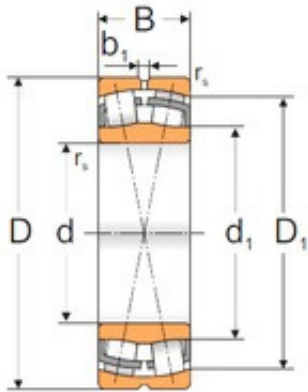

Bearing No. 22316 W33

D	170 mm
d	80 mm
B	58 mm
C	58 mm
d1	99,9 mm
D1	141,6 mm
b1	8 mm
Weight	6,49 Kg
r5 min.	2,1 mm
Size (mm)	80x170x58
Width (mm)	58
Bearing number	22316 W33
Bore Diameter (mm)	80
Outer Diameter (mm)	170
Calculation factor (e)	0,36
(Oil) Lubrication Speed	2800 r/min
Calculation factor (Y0)	1,84
Calculation factor (Y1)	1,88
(Grease) Lubrication Speed	2000 r/min
Basic dynamic load rating (C)	408 kN
Basic static load rating (C0)	517 kN

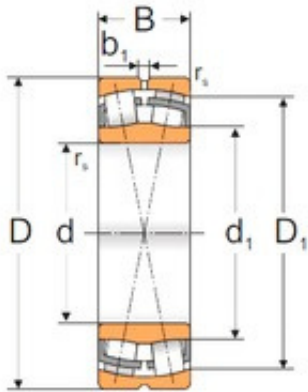

Bearing No. 22315 W33

D	160 mm
d	75 mm
B	55 mm
C	55 mm
d1	94,2 mm
D1	132 mm
b1	8 mm
Weight	5,41 Kg
r5 min.	2,1 mm
Size (mm)	75x160x55
Width (mm)	55
Bearing number	22315 W33
Bore Diameter (mm)	75
Outer Diameter (mm)	160
Calculation factor (e)	0,36
(Oil) Lubrication Speed	3000 r/min
Calculation factor (Y0)	1,81
Calculation factor (Y1)	1,85
(Grease) Lubrication Speed	2200 r/min
Basic dynamic load rating (C)	338 kN
Basic static load rating (C0)	424 kN

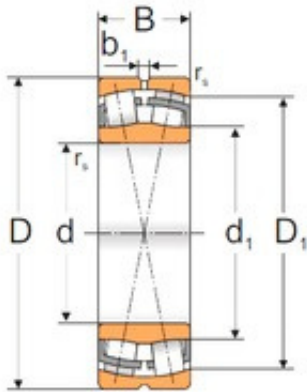

Bearing No. 22314 W33

D	150 mm
d	70 mm
B	51 mm
C	51 mm
d1	87,3 mm
D1	125 mm
b1	8 mm
Weight	4,41 Kg
r5 min.	2,1 mm
Size (mm)	70x150x51
Width (mm)	51
Bearing number	22314 W33
Bore Diameter (mm)	70
Outer Diameter (mm)	150
Calculation factor (e)	0,37
(Oil) Lubrication Speed	3200 r/min
Calculation factor (Y0)	1,78
Calculation factor (Y1)	1,82
(Grease) Lubrication Speed	2400 r/min
Basic dynamic load rating (C)	297 kN
Basic static load rating (C0)	358 kN

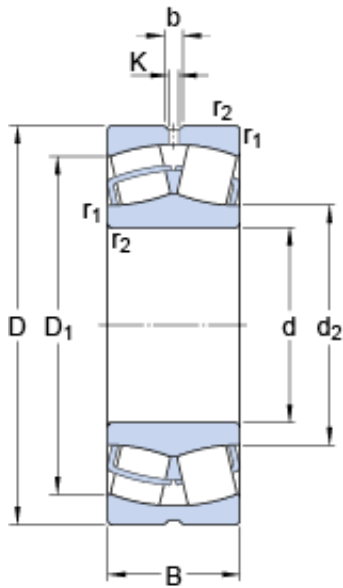

Bearing No. 22312 E

b	8.3 mm
K	4.5 mm
d	60 mm
D	130 mm
B	46 mm
Noun	Bearing
Bore	2.362 Inch 60 Millimeter
Width	1.811 Inch 46 Millimeter
UNSPSC	31171510
series:	223
Category	Spherical Roller Bearing
Size (mm)	130x60x46
Enclosure	Open
Inventory	6.0
bore type:	Straight
Width (mm)	46
cage type:	Inner Ring Guided
maximum rpm:	5300 RPM
Weight / LBS	6.541
Bore Profile	Straight
Mass bearing	3.1 kg
D1	110 mm
Cage Material	Steel
closure type:	Open
d2	77.9 mm
Product Group	B04311
Inch - Metric	Metric
fillet radius:	2 mm

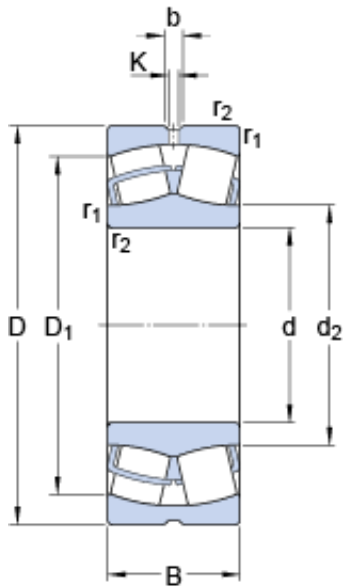

Bearing No. 22313 E

b	8.3 mm
K	4.5 mm
d	65 mm
D	140 mm
B	48 mm
Noun	Bearing
Bore	2.559 Inch 65 Millimeter
Width	1.89 Inch 48 Millimeter
UNSPSC	31171510
series:	223
Category	Spherical Roller Bearing
Size (mm)	140x65x48
Enclosure	Open
Inventory	0.0
bore type:	Straight
Width (mm)	48
cage type:	Inner Ring Guided
maximum rpm:	5000 RPM
Weight / LBS	7.839
Bore Profile	Straight
Mass bearing	3.75 kg
D1	118 mm
Cage Material	Steel
closure type:	Open
d2	81.6 mm
Product Group	B04311
Inch - Metric	Metric
fillet radius:	2 mm
cage material:	Steel

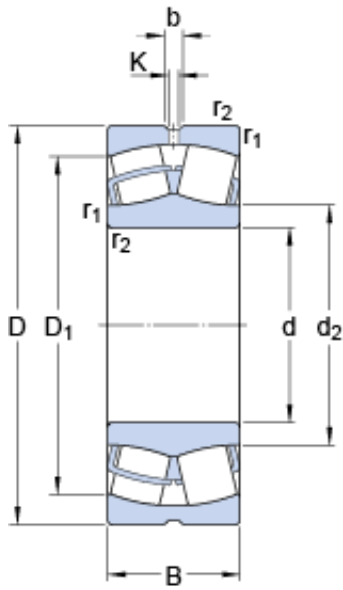

Bearing No. 22311 E

b	5.5 mm
K	3 mm
d	55 mm
D	120 mm
B	43 mm
Noun	Bearing
Bore	2.165 Inch 55 Millimeter
Width	1.693 Inch 43 Millimeter
UNSPSC	31171510
series:	223
Category	Spherical Roller Bearing
Size (mm)	120x55x43
Enclosure	Open
Inventory	56.0
bore type:	Straight
Width (mm)	43
cage type:	Inner Ring Guided
maximum rpm:	5600 RPM
Weight / LBS	5.242
Bore Profile	Straight
Mass bearing	2.45 kg
D1	102 mm
Cage Material	Steel
closure type:	Open
d2	70.1 mm
Product Group	B04311
Inch - Metric	Metric
fillet radius:	2 mm

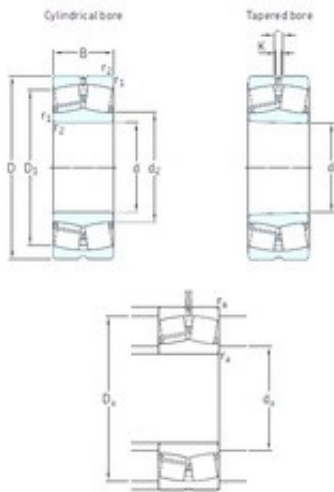

Bearing No. 22310E

C	40 mm
B	40 mm
K	3 mm
b	6 mm
d	50 mm
D	110 mm
d2	63,9 mm
D1	91,9 mm
Weight	1,9 Kg
ra max.	2 mm
r1 min.	2 mm
r2 min.	2 mm
da min.	61 mm
Da max.	99 mm
Size (mm)	50x110x40
Width (mm)	40
Limiting speed	6300 r/min
Bearing number	22310E
Reference speed	4800 r/min
Bore Diameter (mm)	50
Outer Diameter (mm)	110
Calculation factor (e)	0,37
Fatigue load limit (Pu)	24
Calculation factor (Y0)	1,8
Calculation factor (Y1)	1,8
Basic dynamic load rating (C)	220 kN
Basic static load rating (C0)	224 kN

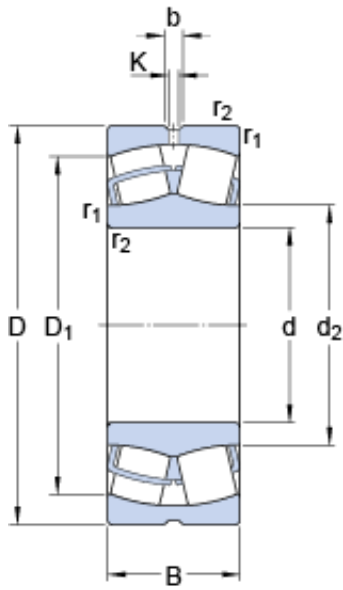

Bearing No. 22308 E

b	6 mm
K	3 mm
d	40 mm
D	90 mm
B	33 mm
Noun	Bearing
Bore	1.575 Inch 40 Millimeter
Width	1.299 Inch 33 Millimeter
UNSPSC	31171510
series:	223
Category	Spherical Roller Bearing
Size (mm)	90x40x33
Enclosure	Open
Inventory	0.0
bore type:	Straight
Width (mm)	33
cage type:	Inner Ring Guided
maximum rpm:	8000 RPM
Weight / LBS	2.266
Bore Profile	Straight
Mass bearing	1.05 kg
D1	74.3 mm
Cage Material	Steel
closure type:	Open
d2	49.9 mm
Product Group	B04311
Inch - Metric	Metric
fillet radius:	1.5 mm

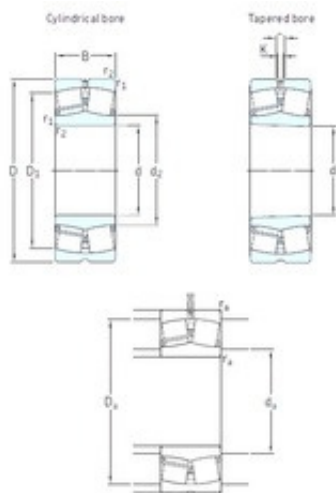

Bearing No. 22309E

C	36 mm
B	36 mm
K	3 mm
b	6 mm
d	45 mm
D	100 mm
d2	57,6 mm
D1	83,4 mm
Weight	1,4 Kg
ra max.	1,5 mm
r1 min.	1,5 mm
r2 min.	1,5 mm
da min.	54 mm
Da max.	91 mm
Size (mm)	45x100x36
Width (mm)	36
Limiting speed	7000 r/min
Bearing number	22309E
Reference speed	5300 r/min
Bore Diameter (mm)	45
Outer Diameter (mm)	100
Calculation factor (e)	0,37
Fatigue load limit (Pu)	19,6
Calculation factor (Y0)	1,8
Calculation factor (Y1)	1,8
Basic dynamic load rating (C)	183 kN
Basic static load rating (C0)	183 kN

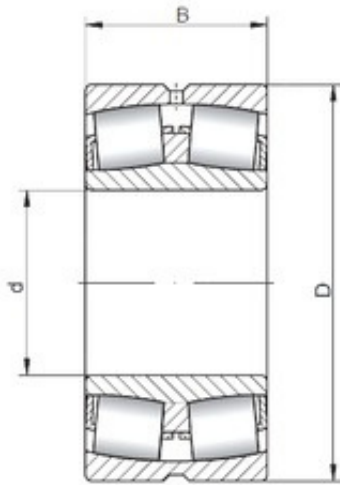

Bearing No. 23038W33

D	290 mm
d	190 mm
B	75 mm
C	75 mm
Size (mm)	190x290x75
Width (mm)	75
Bearing number	23038W33
Bore Diameter (mm)	190
Outer Diameter (mm)	290

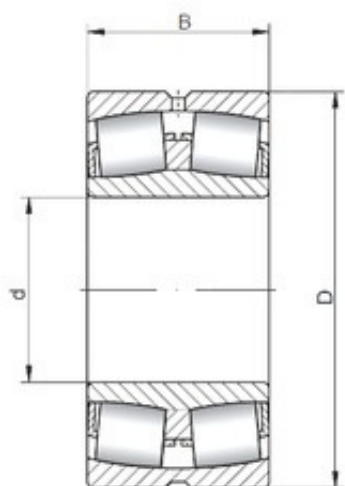

Bearing No. 23036W33

D	280 mm
d	180 mm
B	74 mm
C	74 mm
Size (mm)	180x280x74
Width (mm)	74
Bearing number	23036W33
Bore Diameter (mm)	180
Outer Diameter (mm)	280

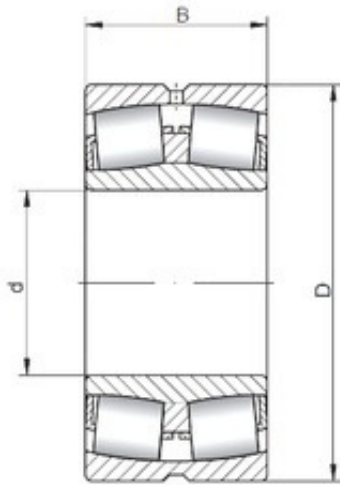

Bearing No. 23034W33

D	260 mm
d	170 mm
B	67 mm
C	67 mm
Size (mm)	170x260x67
Width (mm)	67
Bearing number	23034W33
Bore Diameter (mm)	170
Outer Diameter (mm)	260

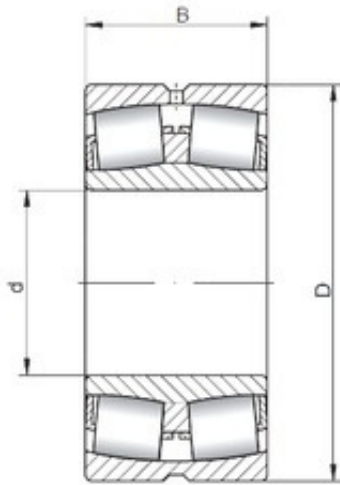

Bearing No. 23032W33

D	240 mm
d	160 mm
B	60 mm
C	60 mm
Size (mm)	160x240x60
Width (mm)	60
Bearing number	23032W33
Bore Diameter (mm)	160
Outer Diameter (mm)	240

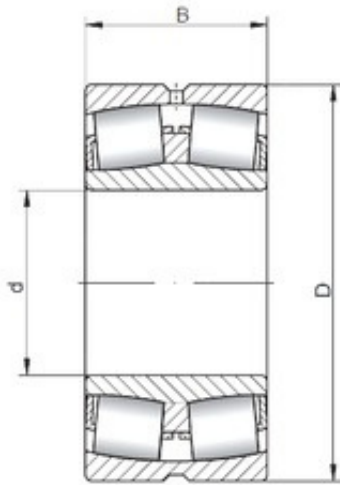

Bearing No. 23030W33

D	225 mm
d	150 mm
B	56 mm
C	56 mm
Size (mm)	150x225x56
Width (mm)	56
Bearing number	23030W33
Bore Diameter (mm)	150
Outer Diameter (mm)	225

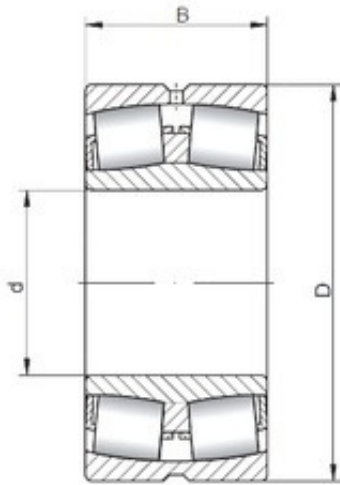

Bearing No. 23028W33

D	210 mm
d	140 mm
B	53 mm
C	53 mm
Size (mm)	140x210x53
Width (mm)	53
Bearing number	23028W33
Bore Diameter (mm)	140
Outer Diameter (mm)	210

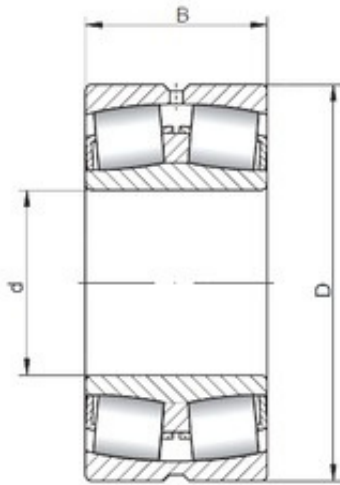

Bearing No. 23026W33

D	200 mm
d	130 mm
B	52 mm
C	52 mm
Size (mm)	130x200x52
Width (mm)	52
Bearing number	23026W33
Bore Diameter (mm)	130
Outer Diameter (mm)	200

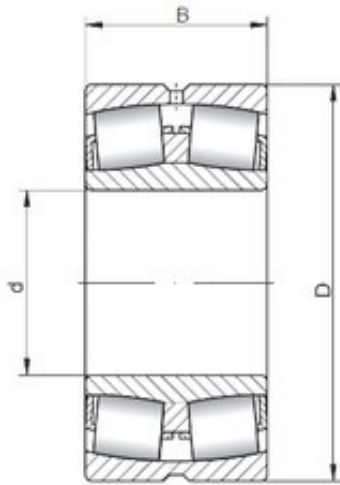

Bearing No. 23024W33

D	180 mm
d	120 mm
B	46 mm
C	46 mm
Size (mm)	120x180x46
Width (mm)	46
Bearing number	23024W33
Bore Diameter (mm)	120
Outer Diameter (mm)	180

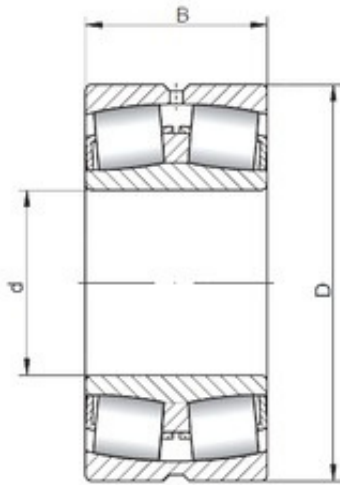

Bearing No. 23022W33

D	170 mm
d	110 mm
B	45 mm
C	45 mm
Size (mm)	110x170x45
Width (mm)	45
Bearing number	23022W33
Bore Diameter (mm)	110
Outer Diameter (mm)	170

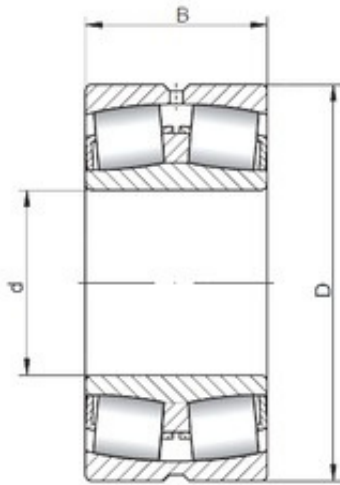

Bearing No. 23134W33

D	280 mm
d	170 mm
B	88 mm
C	88 mm
Size (mm)	170x280x88
Width (mm)	88
Bearing number	23134W33
Bore Diameter (mm)	170
Outer Diameter (mm)	280

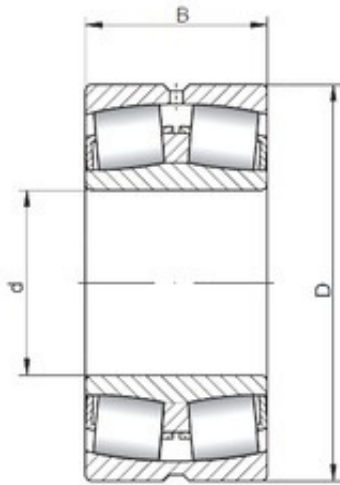

Bearing No. 23132W33

D	270 mm
d	160 mm
B	86 mm
C	86 mm
Size (mm)	160x270x86
Width (mm)	86
Bearing number	23132W33
Bore Diameter (mm)	160
Outer Diameter (mm)	270

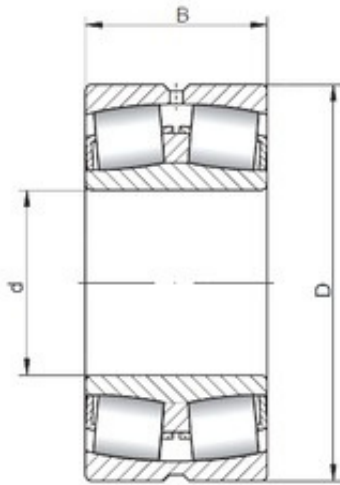

Bearing No. 23128W33

D	225 mm
d	140 mm
B	68 mm
C	68 mm
Size (mm)	140x225x68
Width (mm)	68
Bearing number	23128W33
Bore Diameter (mm)	140
Outer Diameter (mm)	225

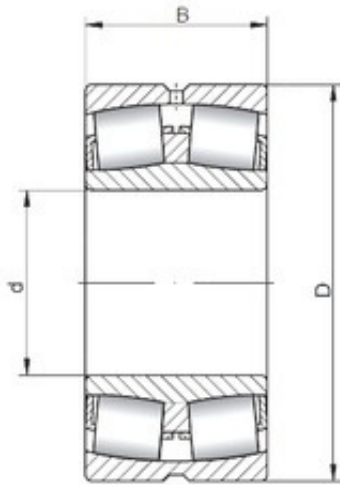

Bearing No. 23130W33

D	250 mm
d	150 mm
B	80 mm
C	80 mm
Size (mm)	150x250x80
Width (mm)	80
Bearing number	23130W33
Bore Diameter (mm)	150
Outer Diameter (mm)	250

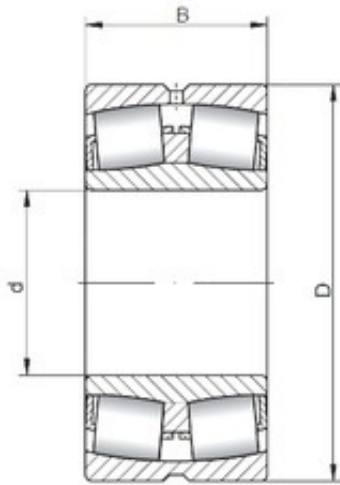

Bearing No. 23126W33

D	210 mm
d	130 mm
B	64 mm
C	64 mm
Size (mm)	130x210x64
Width (mm)	64
Bearing number	23126W33
Bore Diameter (mm)	130
Outer Diameter (mm)	210

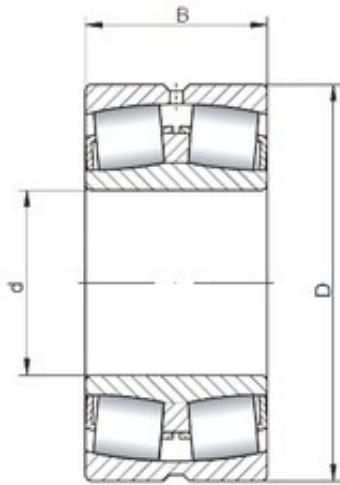

Bearing No. 23124W33

D	200 mm
d	120 mm
B	62 mm
C	62 mm
Size (mm)	120x200x62
Width (mm)	62
Bearing number	23124W33
Bore Diameter (mm)	120
Outer Diameter (mm)	200

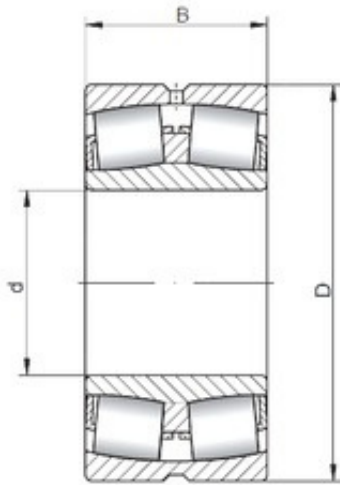

Bearing No. 23122W33

D	180 mm
d	110 mm
B	56 mm
C	56 mm
Size (mm)	110x180x56
Width (mm)	56
Bearing number	23122W33
Bore Diameter (mm)	110
Outer Diameter (mm)	180

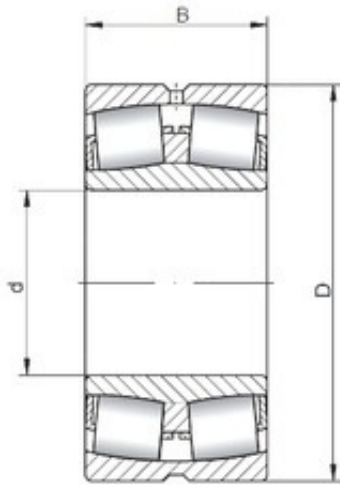

Bearing No. 23120W33

D	165 mm
d	100 mm
B	52 mm
C	52 mm
Size (mm)	100x165x52
Width (mm)	52
Bearing number	23120W33
Bore Diameter (mm)	100
Outer Diameter (mm)	165

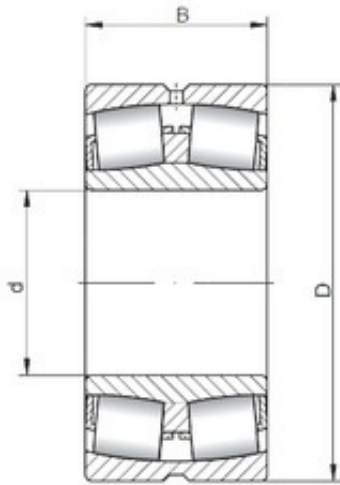

Bearing No. 23236W33

D	320 mm
d	180 mm
B	112 mm
C	112 mm
Size (mm)	180x320x112
Width (mm)	112
Bearing number	23236W33
Bore Diameter (mm)	180
Outer Diameter (mm)	320

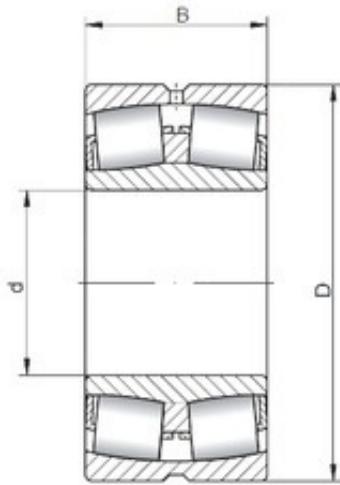

Bearing No. 23234W33

D	310 mm
d	170 mm
B	110 mm
C	110 mm
Size (mm)	170x310x110
Width (mm)	110
Bearing number	23234W33
Bore Diameter (mm)	170
Outer Diameter (mm)	310

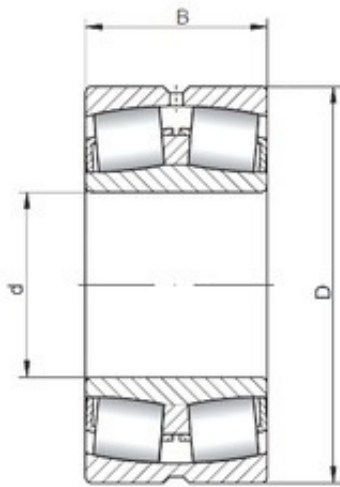

Bearing No. 23232W33

D	290 mm
d	160 mm
B	104 mm
C	104 mm
Size (mm)	160x290x104
Width (mm)	104
Bearing number	23232W33
Bore Diameter (mm)	160
Outer Diameter (mm)	290

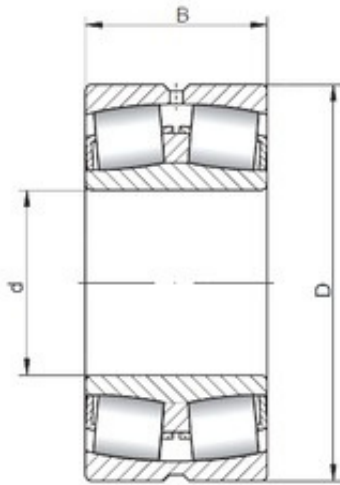

Bearing No. 23230W33

D	270 mm
d	150 mm
B	96 mm
C	96 mm
Size (mm)	150x270x96
Width (mm)	96
Bearing number	23230W33
Bore Diameter (mm)	150
Outer Diameter (mm)	270

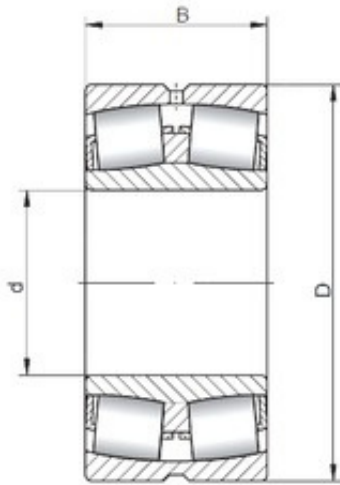

Bearing No. 23228W33

D	250 mm
d	140 mm
B	88 mm
C	88 mm
Size (mm)	140x250x88
Width (mm)	88
Bearing number	23228W33
Bore Diameter (mm)	140
Outer Diameter (mm)	250

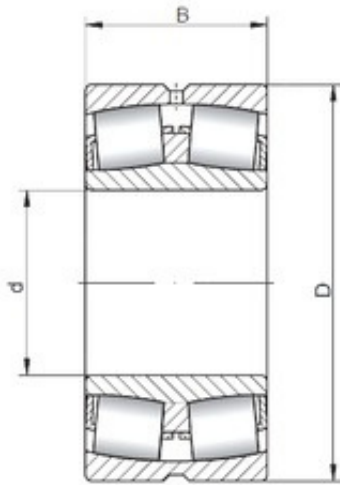

Bearing No. 23226W33

D	230 mm
d	130 mm
B	80 mm
C	80 mm
Size (mm)	130x230x80
Width (mm)	80
Bearing number	23226W33
Bore Diameter (mm)	130
Outer Diameter (mm)	230

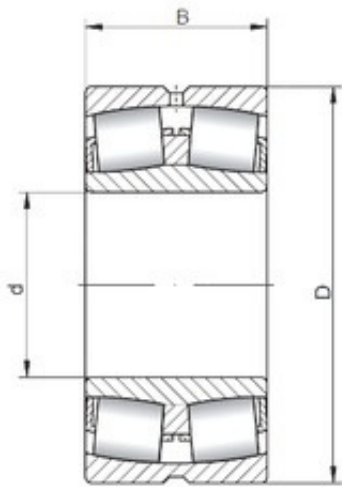

Bearing No. 23224W33

D	215 mm
d	120 mm
B	76 mm
C	76 mm
Size (mm)	120x215x76
Width (mm)	76
Bearing number	23224W33
Bore Diameter (mm)	120
Outer Diameter (mm)	215

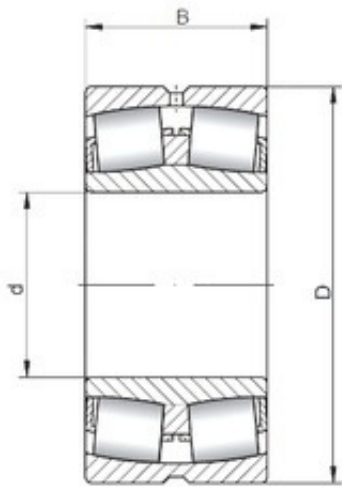

Bearing No. 23222W33

D	200 mm
d	110 mm
B	70 mm
C	70 mm
Size (mm)	110x200x70
Width (mm)	70
Bearing number	23222W33
Bore Diameter (mm)	110
Outer Diameter (mm)	200

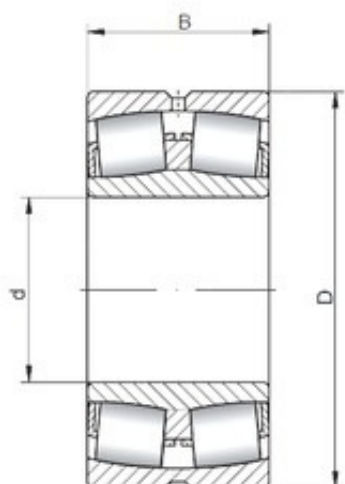

Bearing No. 23220W33

D	180 mm
d	100 mm
B	60.3 mm
C	60.3 mm
Size (mm)	100x180x60.3
Width (mm)	60.3
Bearing number	23220W33
Bore Diameter (mm)	100
Outer Diameter (mm)	180

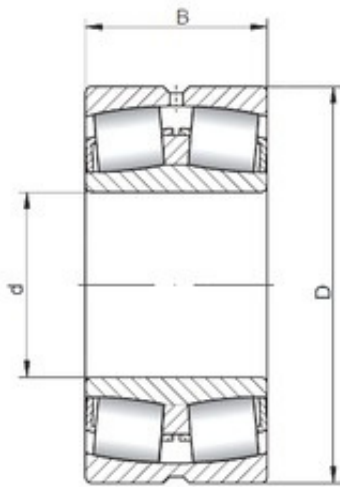

Bearing No. 23218W33

D	160 mm
d	90 mm
B	52.4 mm
C	52.4 mm
Size (mm)	90x160x52.4
Width (mm)	52.4
Bearing number	23218W33
Bore Diameter (mm)	90
Outer Diameter (mm)	160

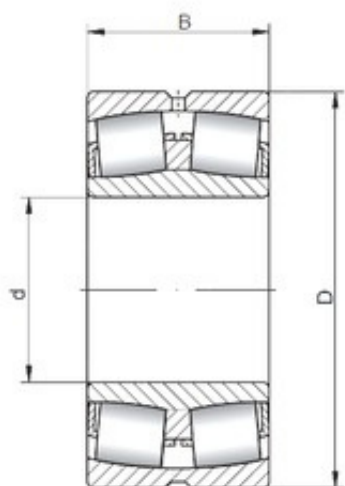

Bearing No. 23972W33

D	480 mm
d	360 mm
B	90 mm
C	90 mm
Size (mm)	360x480x90
Width (mm)	90
Bearing number	23972W33
Bore Diameter (mm)	360
Outer Diameter (mm)	480

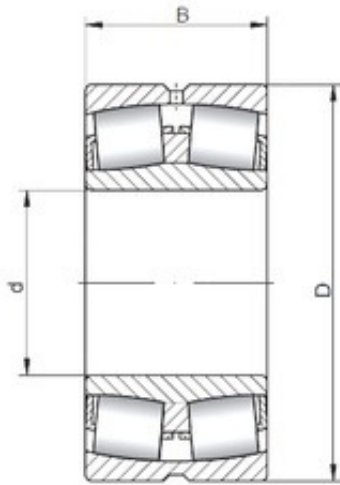

Bearing No. 23968W33

D	460 mm
d	340 mm
B	90 mm
C	90 mm
Size (mm)	340x460x90
Width (mm)	90
Bearing number	23968W33
Bore Diameter (mm)	340
Outer Diameter (mm)	460

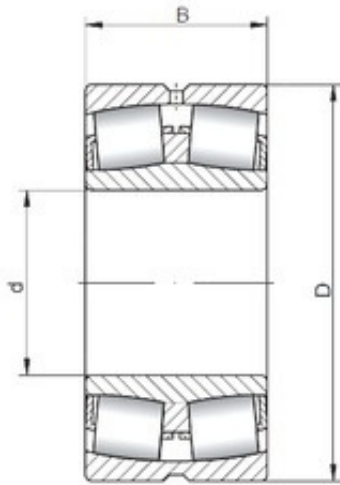

Bearing No. 23960W33

D	420 mm
d	300 mm
B	90 mm
C	90 mm
Size (mm)	300x420x90
Width (mm)	90
Bearing number	23960W33
Bore Diameter (mm)	300
Outer Diameter (mm)	420

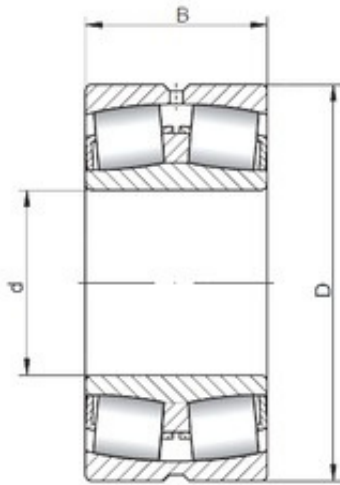

Bearing No. 23956W33

D	380 mm
d	280 mm
B	75 mm
C	75 mm
Size (mm)	280x380x75
Width (mm)	75
Bearing number	23956W33
Bore Diameter (mm)	280
Outer Diameter (mm)	380

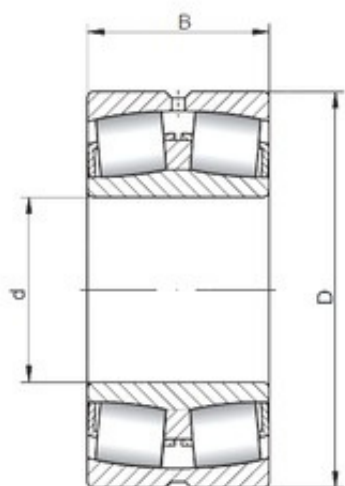

Bearing No. 23952W33

D	360 mm
d	260 mm
B	75 mm
C	75 mm
Size (mm)	260x360x75
Width (mm)	75
Bearing number	23952W33
Bore Diameter (mm)	260
Outer Diameter (mm)	360

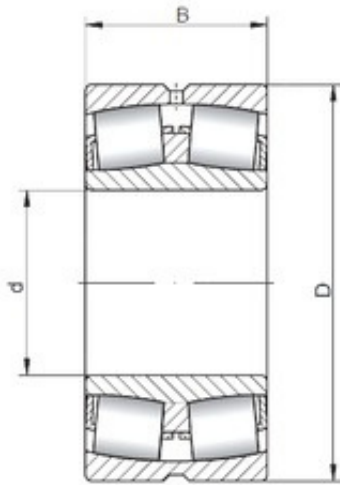

Bearing No. 23948W33

D	320 mm
d	240 mm
B	60 mm
C	60 mm
Size (mm)	240x320x60
Width (mm)	60
Bearing number	23948W33
Bore Diameter (mm)	240
Outer Diameter (mm)	320

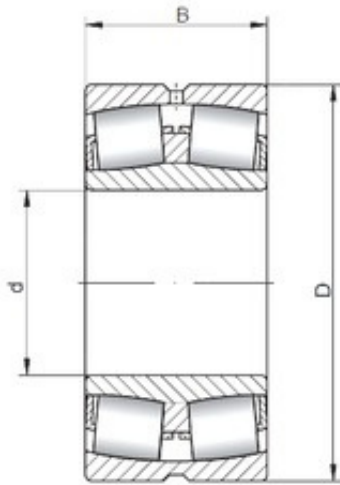

Bearing No. 23944W33

D	300 mm
d	220 mm
B	60 mm
C	60 mm
Size (mm)	220x300x60
Width (mm)	60
Bearing number	23944W33
Bore Diameter (mm)	220
Outer Diameter (mm)	300

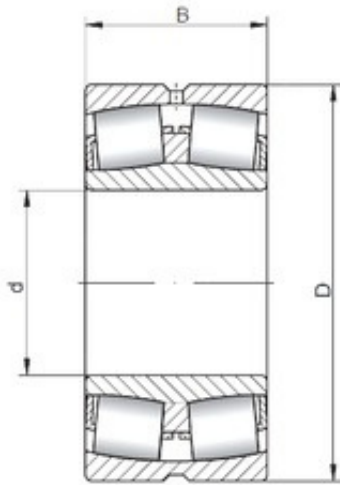

Bearing No. 23940W33

D	280 mm
d	200 mm
B	60 mm
C	60 mm
Size (mm)	200x280x60
Width (mm)	60
Bearing number	23940W33
Bore Diameter (mm)	200
Outer Diameter (mm)	280

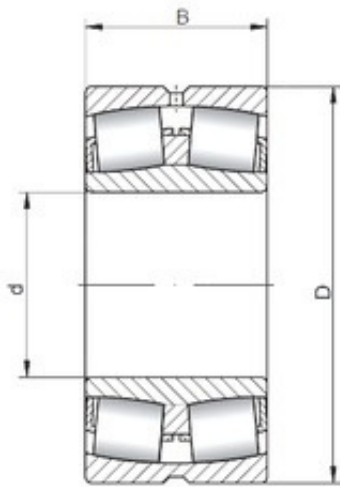

Bearing No. 23938W33

D	260 mm
d	190 mm
B	52 mm
C	52 mm
Size (mm)	190x260x52
Width (mm)	52
Bearing number	23938W33
Bore Diameter (mm)	190
Outer Diameter (mm)	260

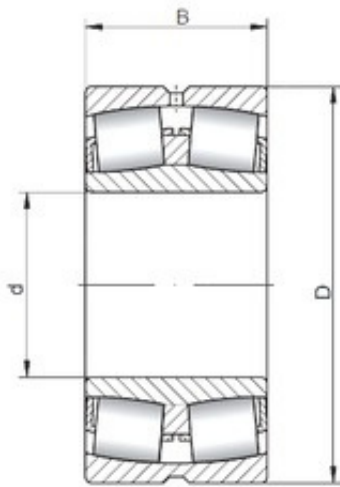

Bearing No. 23936W33

D	250 mm
d	180 mm
B	52 mm
C	52 mm
Size (mm)	180x250x52
Width (mm)	52
Bearing number	23936W33
Bore Diameter (mm)	180
Outer Diameter (mm)	250

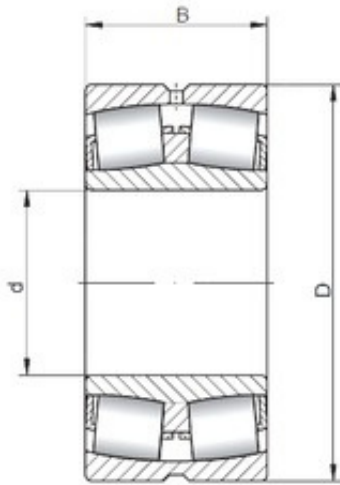

Bearing No. 24044W33

D	340 mm
d	220 mm
B	118 mm
C	118 mm
Size (mm)	220x340x118
Width (mm)	118
Bearing number	24044W33
Bore Diameter (mm)	220
Outer Diameter (mm)	340

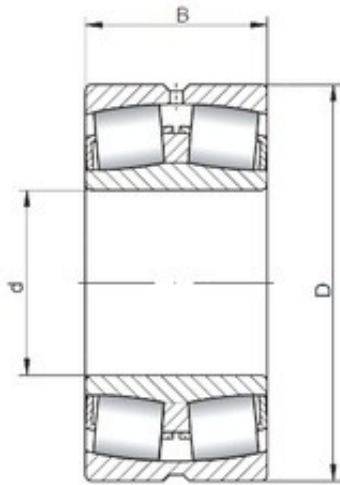

Bearing No. 24040W33

D	310 mm
d	200 mm
B	109 mm
C	109 mm
Size (mm)	200x310x109
Width (mm)	109
Bearing number	24040W33
Bore Diameter (mm)	200
Outer Diameter (mm)	310

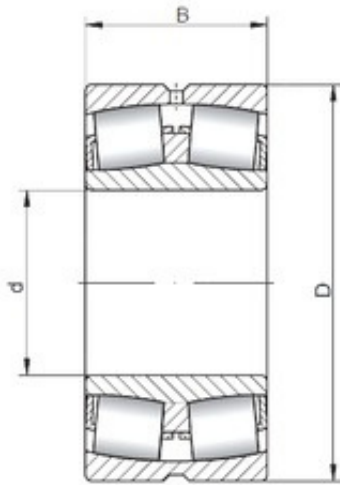

Bearing No. 24038W33

D	290 mm
d	190 mm
B	100 mm
C	100 mm
Size (mm)	190x290x100
Width (mm)	100
Bearing number	24038W33
Bore Diameter (mm)	190
Outer Diameter (mm)	290

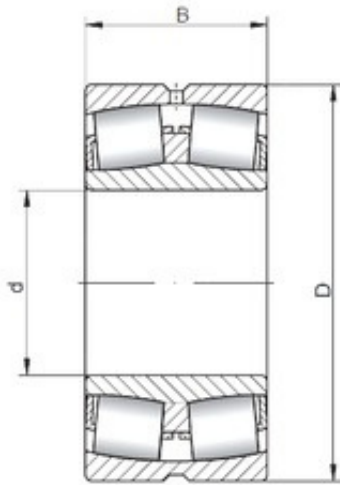

Bearing No. 24036W33

D	280 mm
d	180 mm
B	100 mm
C	100 mm
Size (mm)	180x280x100
Width (mm)	100
Bearing number	24036W33
Bore Diameter (mm)	180
Outer Diameter (mm)	280

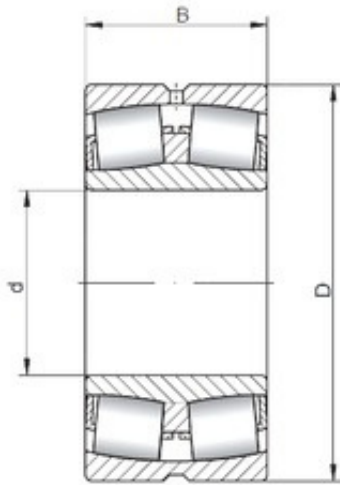

Bearing No. 24034W33

D	260 mm
d	170 mm
B	90 mm
C	90 mm
Size (mm)	170x260x90
Width (mm)	90
Bearing number	24034W33
Bore Diameter (mm)	170
Outer Diameter (mm)	260

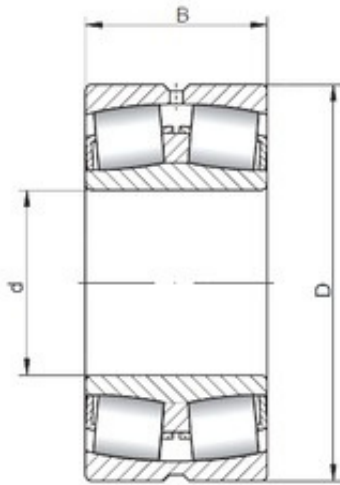

Bearing No. 24032W33

D	240 mm
d	160 mm
B	80 mm
C	80 mm
Size (mm)	160x240x80
Width (mm)	80
Bearing number	24032W33
Bore Diameter (mm)	160
Outer Diameter (mm)	240

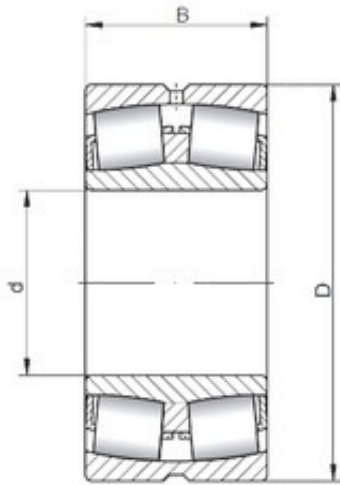

Bearing No. 24030W33

D	225 mm
d	150 mm
B	75 mm
C	75 mm
Size (mm)	150x225x75
Width (mm)	75
Bearing number	24030W33
Bore Diameter (mm)	150
Outer Diameter (mm)	225

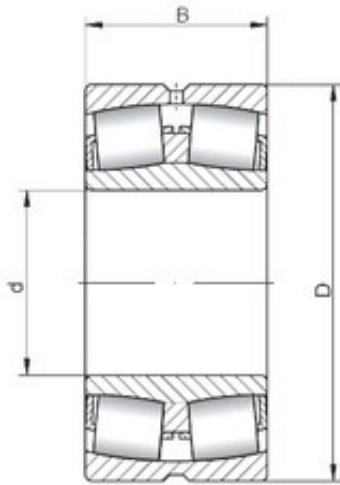

Bearing No. 24028W33

D	210 mm
d	140 mm
B	69 mm
C	69 mm
Size (mm)	140x210x69
Width (mm)	69
Bearing number	24028W33
Bore Diameter (mm)	140
Outer Diameter (mm)	210

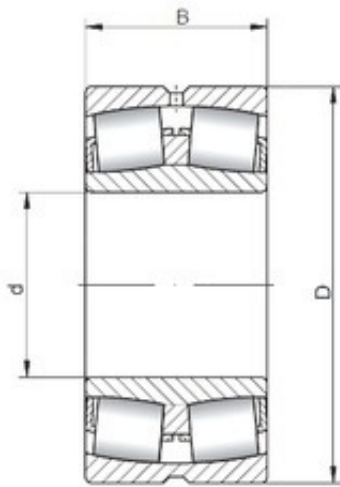

Bearing No. 24026W33

D	200 mm
d	130 mm
B	69 mm
C	69 mm
Size (mm)	130x200x69
Width (mm)	69
Bearing number	24026W33
Bore Diameter (mm)	130
Outer Diameter (mm)	200

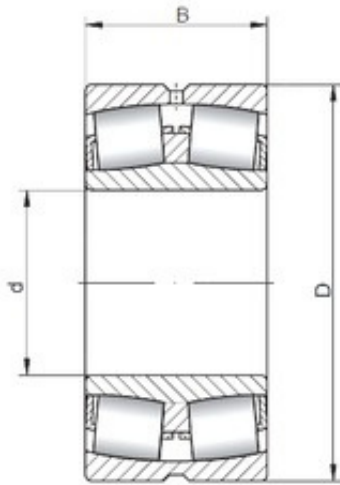

Bearing No. 24024W33

D	180 mm
d	120 mm
B	60 mm
C	60 mm
Size (mm)	120x180x60
Width (mm)	60
Bearing number	24024W33
Bore Diameter (mm)	120
Outer Diameter (mm)	180

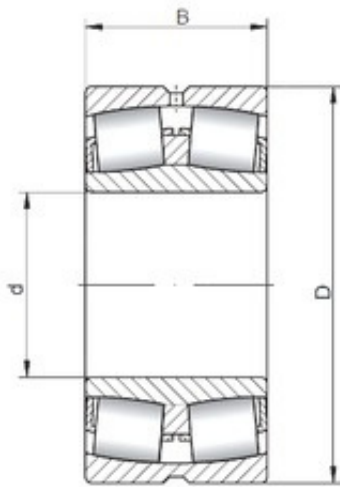

Bearing No. 24140W33

D	340 mm
d	200 mm
B	140 mm
C	140 mm
Size (mm)	200x340x140
Width (mm)	140
Bearing number	24140W33
Bore Diameter (mm)	200
Outer Diameter (mm)	340

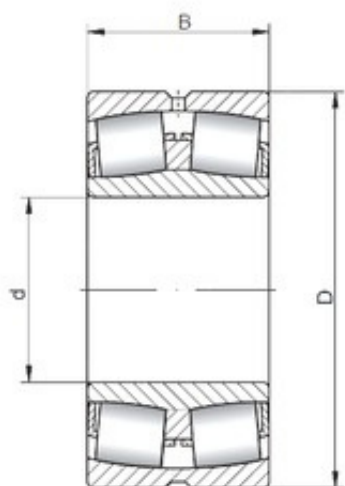

Bearing No. 24138W33

D	320 mm
d	190 mm
B	128 mm
C	128 mm
Size (mm)	190x320x128
Width (mm)	128
Bearing number	24138W33
Bore Diameter (mm)	190
Outer Diameter (mm)	320

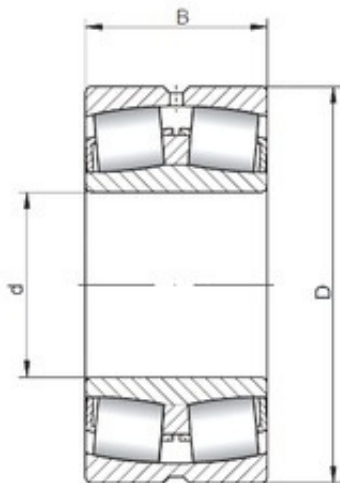

Bearing No. 24136W33

D	300 mm
d	180 mm
B	118 mm
C	118 mm
Size (mm)	180x300x118
Width (mm)	118
Bearing number	24136W33
Bore Diameter (mm)	180
Outer Diameter (mm)	300

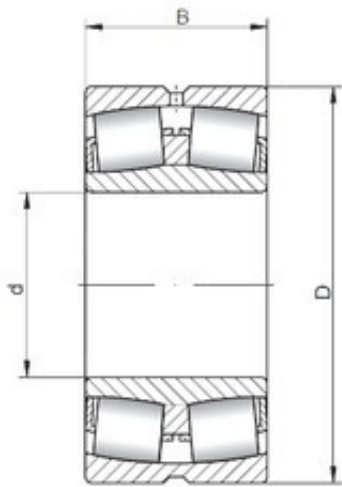

Bearing No. 24134W33

D	280 mm
d	170 mm
B	109 mm
C	109 mm
Size (mm)	170x280x109
Width (mm)	109
Bearing number	24134W33
Bore Diameter (mm)	170
Outer Diameter (mm)	280

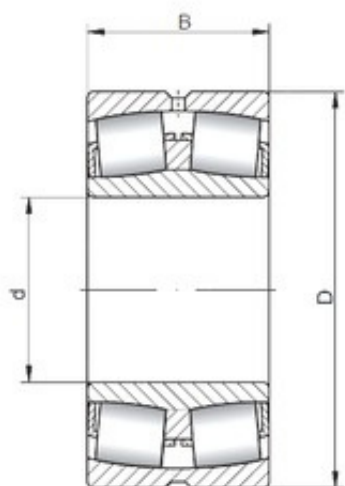

Bearing No. 24132W33

D	270 mm
d	160 mm
B	109 mm
C	109 mm
Size (mm)	160x270x109
Width (mm)	109
Bearing number	24132W33
Bore Diameter (mm)	160
Outer Diameter (mm)	270

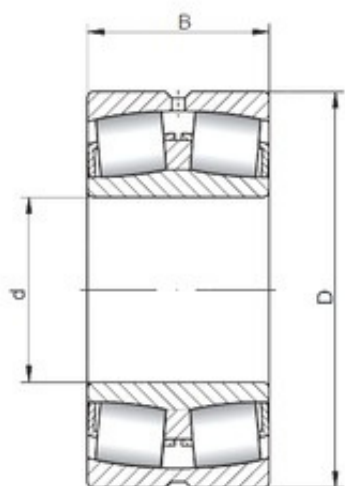

Bearing No. 24130W33

D	250 mm
d	150 mm
B	100 mm
C	100 mm
Size (mm)	150x250x100
Width (mm)	100
Bearing number	24130W33
Bore Diameter (mm)	150
Outer Diameter (mm)	250

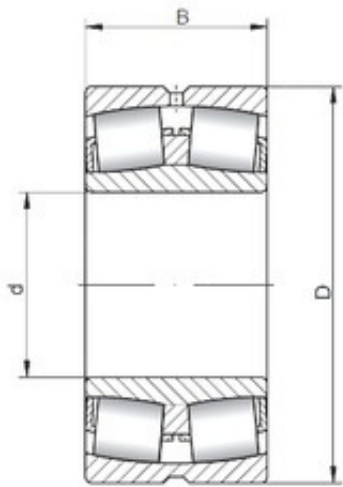

Bearing No. 24128W33

D	225 mm
d	140 mm
B	85 mm
C	85 mm
Size (mm)	140x225x85
Width (mm)	85
Bearing number	24128W33
Bore Diameter (mm)	140
Outer Diameter (mm)	225

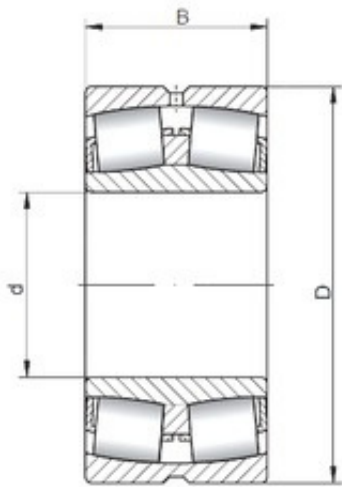

Bearing No. 24126W33

D	210 mm
d	130 mm
B	80 mm
C	80 mm
Size (mm)	130x210x80
Width (mm)	80
Bearing number	24126W33
Bore Diameter (mm)	130
Outer Diameter (mm)	210

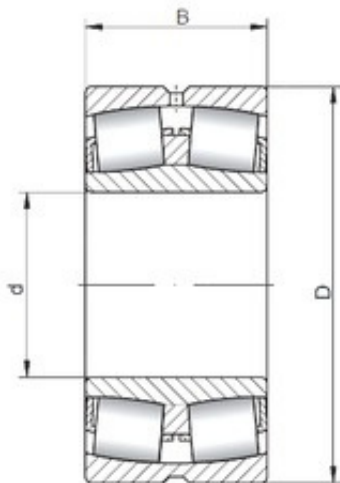

Bearing No. 24124W33

D	200 mm
d	120 mm
B	80 mm
C	80 mm
Size (mm)	120x200x80
Width (mm)	80
Bearing number	24124W33
Bore Diameter (mm)	120
Outer Diameter (mm)	200

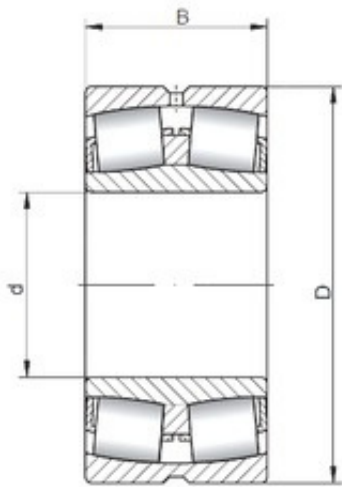

Bearing No. 24122W33

D	180 mm
d	110 mm
B	69 mm
C	69 mm
Size (mm)	110x180x69
Width (mm)	69
Bearing number	24122W33
Bore Diameter (mm)	110
Outer Diameter (mm)	180

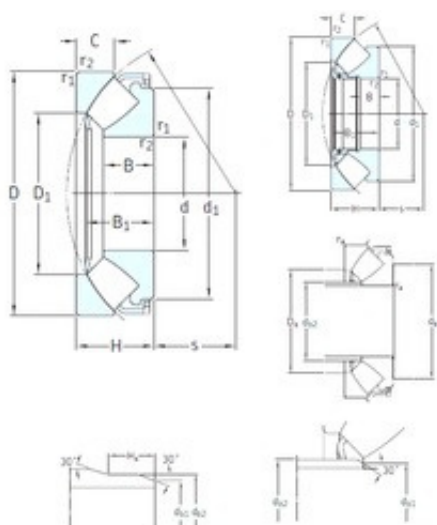

Bearing No. 29334E

B	42,2 mm
H	67 mm
s	96 mm
d	170 mm
D	280 mm
C	30,5 mm
D1	215 mm
B1	61,1 mm
d1	251 mm
Weight	15 Kg
r1 min.	3 mm
r2 min.	3 mm
ra max.	2,5 mm
da min.	220 mm
Da max.	245 mm
db2 max.	188 mm
db1 max.	178 mm
Size (mm)	170x280x30.5
Width (mm)	30,5
Bearing number	29334E
Limiting speed	2200 r/min
Reference speed	1300 r/min
Bore Diameter (mm)	170
Outer Diameter (mm)	280
Fatigue load limit (Pu)	365
Basic dynamic load rating (C)	1200 kN
Basic static load rating (C0)	3550 kN

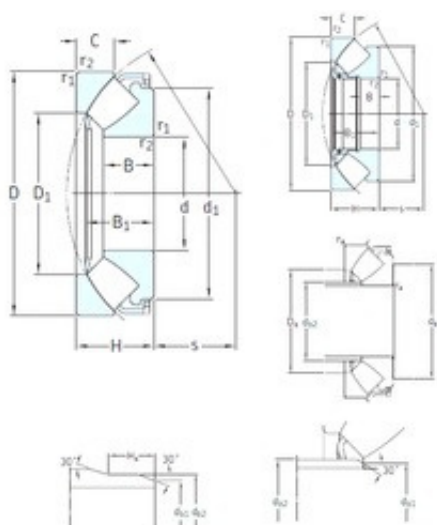

Bearing No. 29332E

B	42 mm
H	67 mm
s	92 mm
d	160 mm
D	270 mm
C	33 mm
D1	203 mm
B1	60 mm
d1	243 mm
Weight	14,5 Kg
r1 min.	3 mm
r2 min.	3 mm
ra max.	2,5 mm
da min.	210 mm
Da max.	235 mm
db2 max.	176 mm
db1 max.	169 mm
Size (mm)	160x270x33
Width (mm)	33
Bearing number	29332E
Limiting speed	2200 r/min
Reference speed	1300 r/min
Bore Diameter (mm)	160
Outer Diameter (mm)	270
Fatigue load limit (Pu)	375
Basic dynamic load rating (C)	1180 kN
Basic static load rating (C0)	3450 kN

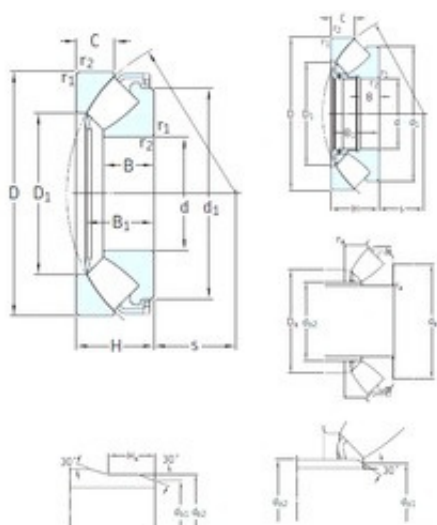

Bearing No. 29330E

B	38 mm
H	60 mm
s	87 mm
d	150 mm
D	250 mm
C	28 mm
D1	190 mm
B1	54,9 mm
d1	223 mm
Weight	11 Kg
r1 min.	2,1 mm
r2 min.	2,1 mm
ra max.	2 mm
da min.	195 mm
Da max.	219 mm
db2 max.	163 mm
db1 max.	158 mm
Size (mm)	150x250x28
Width (mm)	28
Bearing number	29330E
Limiting speed	2400 r/min
Reference speed	1500 r/min
Bore Diameter (mm)	150
Outer Diameter (mm)	250
Fatigue load limit (Pu)	315
Basic dynamic load rating (C)	1000 kN
Basic static load rating (C0)	2850 kN

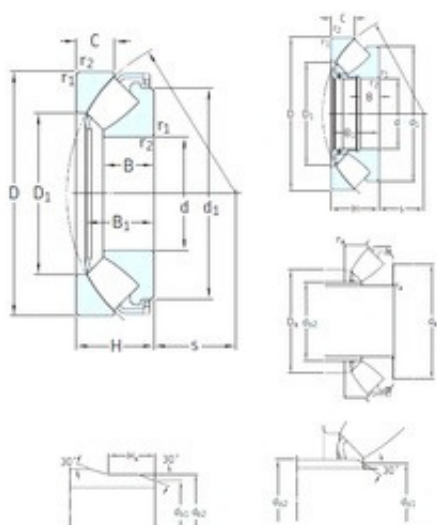

Bearing No. 29328E

B	38,5 mm
H	60 mm
s	82 mm
d	140 mm
D	240 mm
C	30 mm
D1	177 mm
B1	54 mm
d1	216 mm
Weight	10,5 Kg
r1 min.	2,1 mm
r2 min.	2,1 mm
ra max.	2 mm
da min.	185 mm
Da max.	208 mm
db2 max.	154 mm
db1 max.	148 mm
Size (mm)	140x240x30
Width (mm)	30
Bearing number	29328E
Limiting speed	2600 r/min
Reference speed	1500 r/min
Bore Diameter (mm)	140
Outer Diameter (mm)	240
Fatigue load limit (Pu)	315
Basic dynamic load rating (C)	980 kN
Basic static load rating (C0)	2850 kN

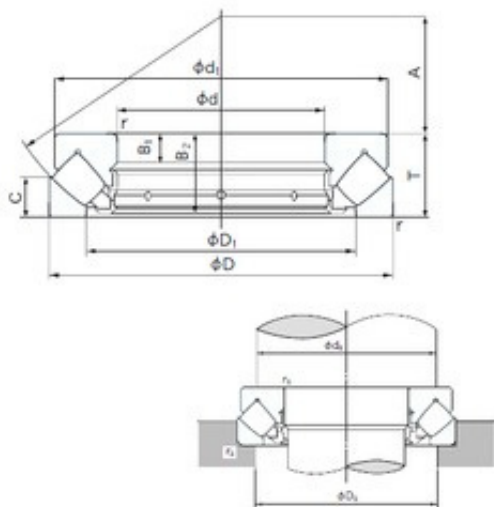

Bearing No. 29326E

C	28 mm
B	19 mm
d	130 mm
D	225 mm
T	58 mm
A	76 mm
B1	19 mm
D1	171 mm
d1	215 mm
B2	55 mm
Width	58 mm
r min.	2.1 mm
Weight	9.45 Kg
da min.	170 mm
Da max.	195 mm
ra max.	2 mm
da (min)	170 mm
Da (max)	195 mm
ra (max)	2 mm
Bore Type	Cylindrical Bore
Enclosure	Open
Bore Size	130 mm
Size (mm)	130x225x58
Width (mm)	58
Configuration	Single Row
Bearing number	29326E
Outside Diameter	225 mm
Static Load Rating	2,420,000 N
Bore Diameter (mm)	130
Dynamic Load Rating	665,000 N

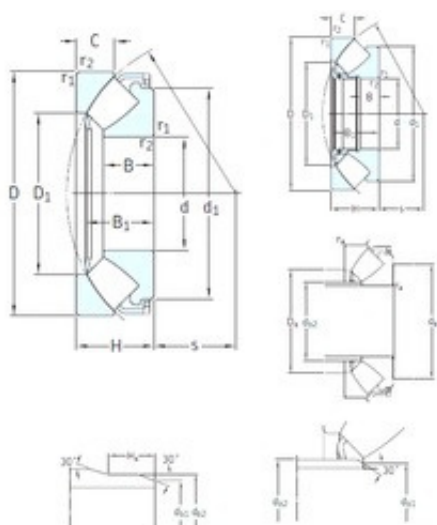

Bearing No. 29324E

B	34 mm
H	54 mm
s	70 mm
d	120 mm
D	210 mm
C	27 mm
D1	155 mm
B1	48,2 mm
d1	188 mm
Weight	7,35 Kg
r1 min.	2,1 mm
r2 min.	2,1 mm
ra max.	2 mm
da min.	160 mm
Da max.	181 mm
db2 max.	128 mm
db1 max.	128 mm
Size (mm)	120x210x27
Width (mm)	27
Bearing number	29324E
Limiting speed	2800 r/min
Reference speed	1700 r/min
Bore Diameter (mm)	120
Outer Diameter (mm)	210
Fatigue load limit (Pu)	245
Basic dynamic load rating (C)	765 kN
Basic static load rating (C0)	2120 kN

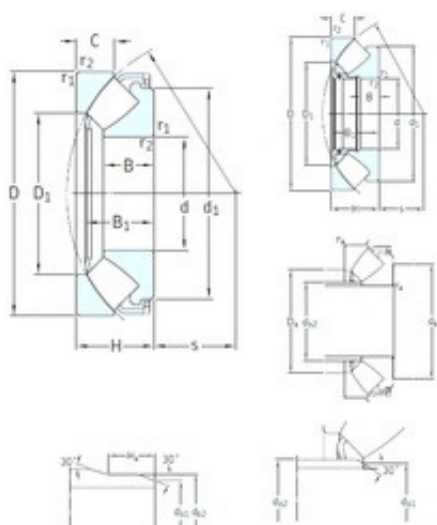

Bearing No. 29322E

B	30,3 mm
H	48 mm
s	63,8 mm
d	110 mm
D	190 mm
C	24,8 mm
D1	140 mm
B1	41,7 mm
d1	171 mm
Weight	5,3 Kg
r1 min.	2 mm
r2 min.	2 mm
ra max.	2 mm
da min.	145 mm
Da max.	164 mm
db2 max.	117 mm
db1 max.	117 mm
Size (mm)	110x190x24.8
Width (mm)	24,8
Bearing number	29322E
Limiting speed	3200 r/min
Reference speed	1900 r/min
Bore Diameter (mm)	110
Outer Diameter (mm)	190
Fatigue load limit (Pu)	204
Basic dynamic load rating (C)	610 kN
Basic static load rating (C0)	1730 kN

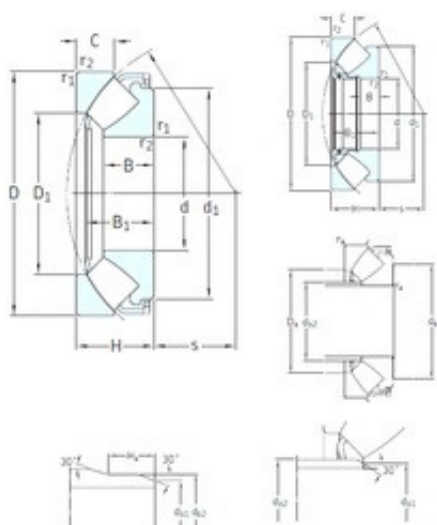

Bearing No. 29320E

B	26,2 mm
H	42 mm
s	58 mm
d	100 mm
D	170 mm
C	20,5 mm
D1	128 mm
B1	36,3 mm
d1	152 mm
Weight	3,65 Kg
r1 min.	1,5 mm
r2 min.	1,5 mm
ra max.	1,5 mm
da min.	130 mm
Da max.	147 mm
db2 max.	107 mm
db1 max.	107 mm
Size (mm)	100x170x20.5
Width (mm)	20,5
Bearing number	29320E
Limiting speed	3600 r/min
Reference speed	2200 r/min
Bore Diameter (mm)	100
Outer Diameter (mm)	170
Fatigue load limit (Pu)	156
Basic dynamic load rating (C)	465 kN
Basic static load rating (C0)	1290 kN

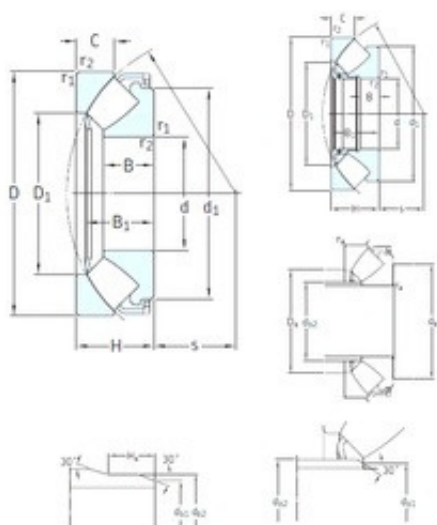

Bearing No. 29317E

B	24,5 mm
H	39 mm
s	50 mm
d	85 mm
D	150 mm
C	20 mm
D1	110 mm
B1	33,8 mm
d1	134 mm
Weight	2,75 Kg
r1 min.	1,5 mm
r2 min.	1,5 mm
ra max.	1,5 mm
da min.	115 mm
Da max.	129 mm
db2 max.	90 mm
db1 max.	90 mm
Size (mm)	85x150x20
Width (mm)	20
Bearing number	29317E
Limiting speed	4000 r/min
Reference speed	2400 r/min
Bore Diameter (mm)	85
Outer Diameter (mm)	150
Fatigue load limit (Pu)	129
Basic dynamic load rating (C)	380 kN
Basic static load rating (C0)	1060 kN

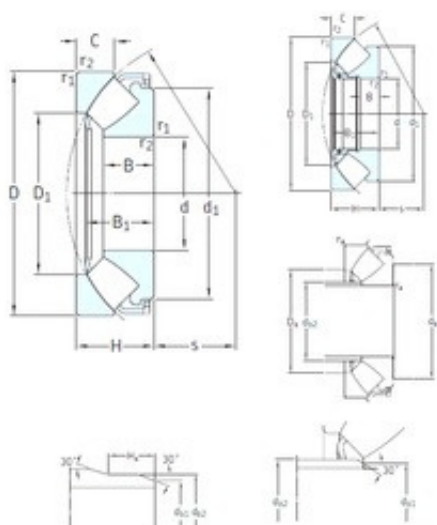

Bearing No. 29318E

B	24,5 mm
H	39 mm
s	53 mm
d	90 mm
D	155 mm
C	19,5 mm
D1	115 mm
B1	34,5 mm
d1	138 mm
Weight	2,85 Kg
r1 min.	1,5 mm
r2 min.	1,5 mm
ra max.	1,5 mm
da min.	120 mm
Da max.	134 mm
db2 max.	95 mm
db1 max.	95 mm
Size (mm)	90x155x19.5
Width (mm)	19,5
Bearing number	29318E
Limiting speed	4000 r/min
Reference speed	2400 r/min
Bore Diameter (mm)	90
Outer Diameter (mm)	155
Fatigue load limit (Pu)	132
Basic dynamic load rating (C)	400 kN
Basic static load rating (C0)	1080 kN

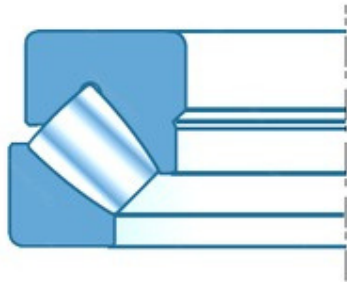

Bearing No. 29424E

D	250,000 mm
d	120,000 mm
H	78,000 mm
Size (mm)	120x250x78
Width (mm)	78,000
Bearing number	29424E
Bore Diameter (mm)	120,000
Outer Diameter (mm)	250,000

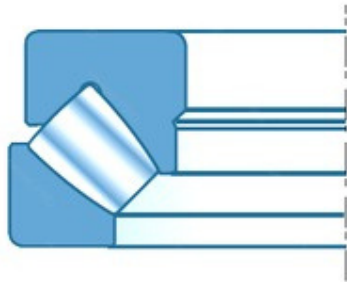

Bearing No. 29422E

D	230,000 mm
d	110,000 mm
H	73,000 mm
Size (mm)	110x230x73
Width (mm)	73,000
Bearing number	29422E
Bore Diameter (mm)	110,000
Outer Diameter (mm)	230,000

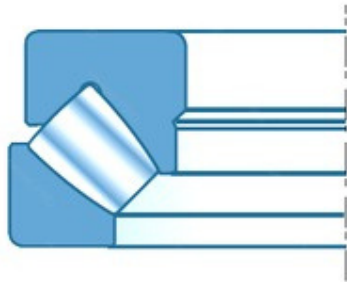

Bearing No. 29420E

D	210,000 mm
d	100,000 mm
H	67,000 mm
Size (mm)	100x210x67
Width (mm)	67,000
Bearing number	29420E
Bore Diameter (mm)	100,000
Outer Diameter (mm)	210,000

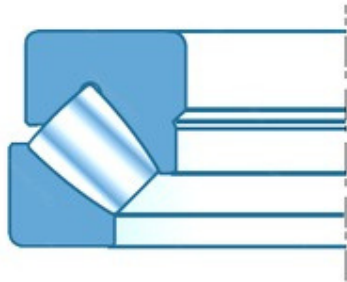

Bearing No. 29417E

D	180,000 mm
d	85,000 mm
H	58,000 mm
Size (mm)	85x180x58
Width (mm)	58,000
Bearing number	29417E
Bore Diameter (mm)	85,000
Outer Diameter (mm)	180,000

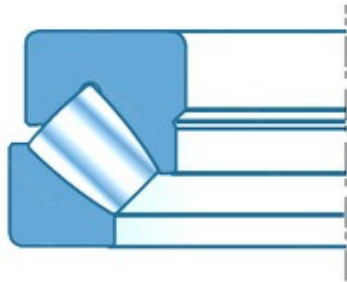

Bearing No. 29416E

D	170,000 mm
d	80,000 mm
H	54,000 mm
Size (mm)	80x170x54
Width (mm)	54,000
Bearing number	29416E
Bore Diameter (mm)	80,000
Outer Diameter (mm)	170,000

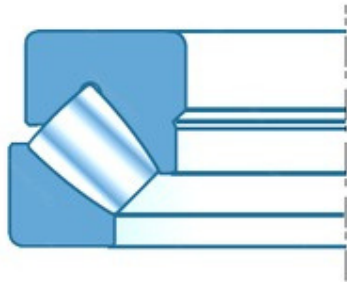

Bearing No. 29415E

D	160,000 mm
d	75,000 mm
H	51,000 mm
Size (mm)	75x160x51
Width (mm)	51,000
Bearing number	29415E
Bore Diameter (mm)	75,000
Outer Diameter (mm)	160,000

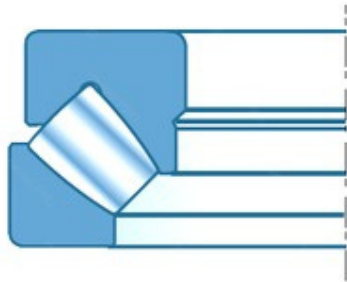

Bearing No. 29414E

D	150,000 mm
d	70,000 mm
H	48,000 mm
Size (mm)	70x150x48
Width (mm)	48,000
Bearing number	29414E
Bore Diameter (mm)	70,000
Outer Diameter (mm)	150,000

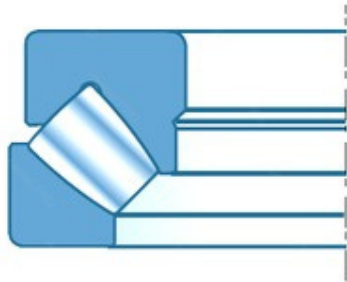

Bearing No. 29413E

D	140,000 mm
d	65,000 mm
H	45,000 mm
Size (mm)	65x140x45
Width (mm)	45,000
Bearing number	29413E
Bore Diameter (mm)	65,000
Outer Diameter (mm)	140,000

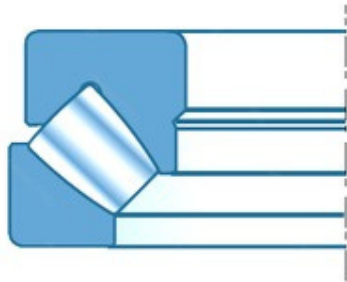

Bearing No. 29412E

D	130,000 mm
d	60,000 mm
H	42,000 mm
Size (mm)	60x130x42
Width (mm)	42,000
Bearing number	29412E
Bore Diameter (mm)	60,000
Outer Diameter (mm)	130,000

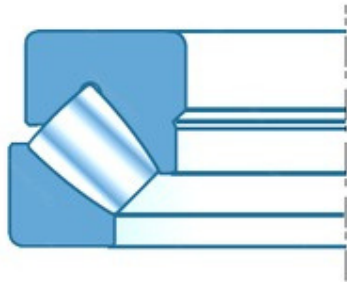

Bearing No. 29418E

D	190,000 mm
d	90,000 mm
H	60,000 mm
Size (mm)	90x190x60
Width (mm)	60,000
Bearing number	29418E
Bore Diameter (mm)	90,000
Outer Diameter (mm)	190,000

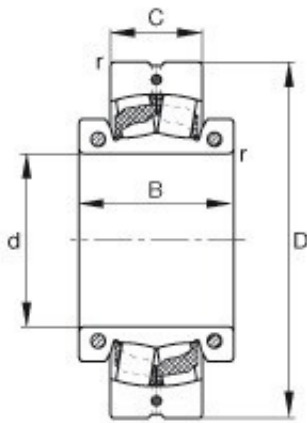

Bearing No. 222S.303

	H318.303
e	0,22
C	40 mm
m	4,27 kg / Weight
B	70 mm
d	3 3/16 inch
D	160 mm
SNV160	Designation, plummer block housing
SNW18.303	Designation, adapter sleeve, US design
Size (mm)	80.963x160x40
Width (mm)	40
nG	2160 1/min / Limiting speed
Ma	9 Nm / Tightening torque per clamping screw
Mi	14 Nm / Tightening torque per clamping screw
Y	3,07
0	4,67
Y	3,14
2	212000 N / Dynamic load rating (radial)
Y	
C0r 1	270000 N / Static load rating (radial)
Curr	25500 N / Fatigue limit load, radial
Bearing number	222S.303
rmin	2 mm
Fa max	7600 N / Permissible

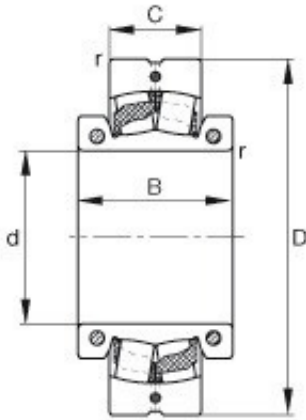

Bearing No. 222S.300

	H317.300
e	0,22
C	36 mm
m	3,88 kg / Weight
B	68 mm
d	3 inch
D	150 mm
SNV150	Designation, plummer block housing
SNW17.300	Designation, adapter sleeve, US design
Size (mm)	76.2x150x36
Width (mm)	36
nG	2280 1/min / Limiting speed
Ma	9 Nm / Tightening torque per clamping screw
Mi	14 Nm / Tightening torque per clamping screw
Y	3,03
0	4,62
Y	3,1
2	183000 N / Dynamic load rating (radial)
Y	
C0r 1	236000 N / Static load rating (radial)
Curr	22500 N / Fatigue limit load, radial
Bearing number	222S.300
rmin	2 mm
Fa max	7600 N / Permissible

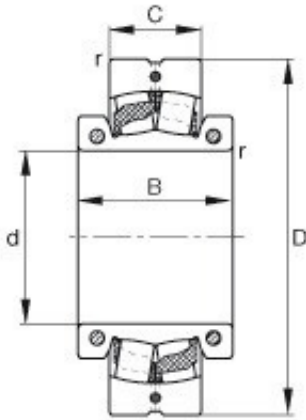

Bearing No. 222S.215

	H317.215
e	0,22
C	36 mm
m	3,94 kg / Weight
B	68 mm
d	2 15/16 inch
D	150 mm
SNV150	Designation, plummer block housing
SNW17.215	Designation, adapter sleeve, US design
Size (mm)	74.613x150x36
Width (mm)	36
nG	2280 1/min / Limiting speed
Ma	9 Nm / Tightening torque per clamping screw
Mi	14 Nm / Tightening torque per clamping screw
Y	3,03
0	4,62
Y	3,1
2	183000 N / Dynamic load rating (radial)
Y	
C0r 1	236000 N / Static load rating (radial)
Curr	22500 N / Fatigue limit load, radial
Bearing number	222S.215
rmin	2 mm
Fa max	7600 N / Permissible

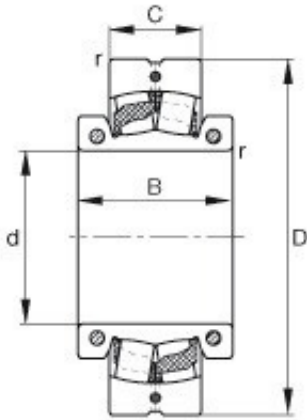

Bearing No. 222S.211

	H316.211
e	0,23
C	33 mm
m	3,27 kg / Weight
B	62 mm
d	2 11/16 inch
D	140 mm
SNV140	Designation, plummer block housing
SNW16.211	Designation, adapter sleeve, US design
Size (mm)	68.263x140x33
Width (mm)	33
nG	2340 1/min / Limiting speed
Ma	4 Nm / Tightening torque per clamping screw
Mi	9 Nm / Tightening torque per clamping screw
Y0	2,89
Y2	4,4
Y1	2,95
Cr	180000 N / Dynamic load rating (radial)
C0r	228000 N / Static load rating (radial)
Cur	21100 N / Fatigue limit load, radial
Bearing number	222S.211
rmin	2 mm
Fa max	5400 N / Permissible axial load, for inner ring

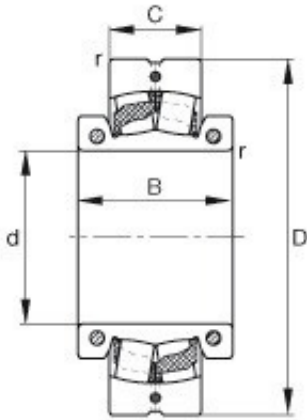

Bearing No. 222S.208

	H315.208
e	0,24
C	31 mm
m	2,47 kg / Weight
B	60 mm
d	2 1/2 inch
D	130 mm
SNV130	Designation, plummer block housing
SNW15.208	Designation, adapter sleeve, US design
Size (mm)	63.5x130x31
Width (mm)	31
nG	2440 1/min / Limiting speed
Ma	4 Nm / Tightening torque per clamping screw
Mi	9 Nm / Tightening torque per clamping screw
Y0	2,75
Y2	4,19
Y1	2,81
Cr	173000 N / Dynamic load rating (radial)
C0r	208000 N / Static load rating (radial)
Cur	19400 N / Fatigue limit load, radial
Bearing number	222S.208
rmin	1,5 mm
Fa max	5400 N / Permissible axial load, for inner ring

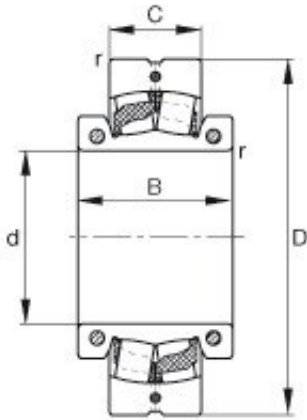

Bearing No. 222S.207

	H315.207
e	0,24
C	31 mm
m	2,81 kg / Weight
B	60 mm
d	2 7/16 inch
D	130 mm
SNV130	Designation, plummer block housing
SNW15.207	Designation, adapter sleeve, US design
Size (mm)	61.913x130x31
Width (mm)	31
nG	2440 1/min / Limiting speed
Ma	4 Nm / Tightening torque per clamping screw
Mi	9 Nm / Tightening torque per clamping screw
Y0	2,75
Y2	4,19
Y1	2,81
Cr	173000 N / Dynamic load rating (radial)
C0r	208000 N / Static load rating (radial)
Cur	19400 N / Fatigue limit load, radial
Bearing number	222S.207
rmin	1,5 mm
Fa max	5400 N / Permissible axial load, for inner ring

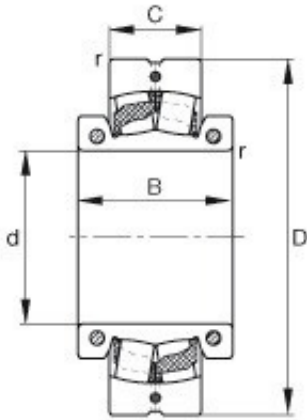

Bearing No. 222S.204

	H313.204
e	0,23
C	31 mm
m	2,19 kg / Weight
B	55 mm
d	2 1/4 inch
D	120 mm
SNV120	Designation, plummer block housing
SNW13.204	Designation, adapter sleeve, US design
Size (mm)	57.15x120x31
Width (mm)	31
nG	2850 1/min / Limiting speed
Ma	4 Nm / Tightening torque per clamping screw
Mi	9 Nm / Tightening torque per clamping screw
Y0	2,92
Y2	4,44
Y1	2,98
Cr	137000 N / Dynamic load rating (radial)
C0r	156000 N / Static load rating (radial)
Cur	15400 N / Fatigue limit load, radial
Bearing number	222S.204
rmin	1,5 mm
Fa max	5400 N / Permissible axial load, for inner ring

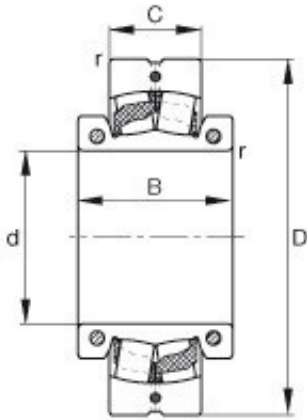

Bearing No. 222S.203

	H313.203
e	0,23
C	31 mm
m	2,25 kg / Weight
B	55 mm
d	2 3/16 inch
D	120 mm
SNV120	Designation, plummer block housing
SNW13.203	Designation, adapter sleeve, US design
Size (mm)	55.563x120x31
Width (mm)	31
nG	2850 1/min / Limiting speed
Ma	4 Nm / Tightening torque per clamping screw
Mi	9 Nm / Tightening torque per clamping screw
Y0	2,92
Y2	4,44
Y1	2,98
Cr	137000 N / Dynamic load rating (radial)
C0r	156000 N / Static load rating (radial)
Cur	15400 N / Fatigue limit load, radial
Bearing number	222S.203
rmin	1,5 mm
Fa max	5400 N / Permissible axial load, for inner ring