

Bearing No. B-5612

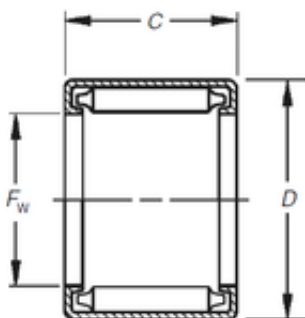

D	101,6 mm
C	19,05 mm
Fw	88,9 mm
Weight	0,212 Kg
Size (mm)	88.9x101.6x19.05
Width (mm)	19,05
Bearing number	B-5612
Bore Diameter (mm)	88,9
Outer Diameter (mm)	101,6
(Grease) Lubrication Speed	1800 r/min
Basic dynamic load rating (C)	64,9 kN
Basic static load rating (C0)	150 kN