

Bearing No. B-4216

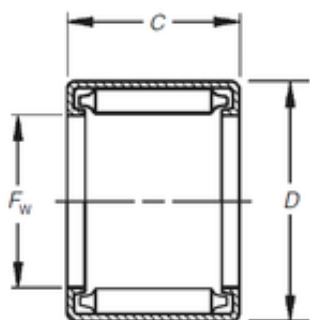

D	76,2 mm
C	25,4 mm
Fw	66,675 mm
Weight	0,159 Kg
Size (mm)	66.675x76.2x25.4
Width (mm)	25,4
Bearing number	B-4216
Bore Diameter (mm)	66,675
Outer Diameter (mm)	76,2
(Grease) Lubrication Speed	1700 r/min
Basic dynamic load rating (C)	66,7 kN
Basic static load rating (C0)	182 kN