

### Bearing No. B-3624

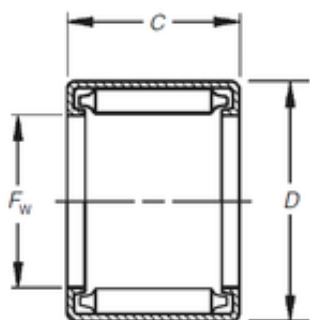

D	66,675 mm
C	38,1 mm
Fw	57,15 mm
Weight	0,207 Kg
Size (mm)	57.15x66.675x38.1
Width (mm)	38,1
Bearing number	B-3624
Bore Diameter (mm)	57,15
Outer Diameter (mm)	66,675
(Grease) Lubrication Speed	2000 r/min
Basic dynamic load rating (C)	92,1 kN
Basic static load rating (C0)	257 kN