

### Bearing No. 1207

D	72 mm
d	35 mm
B	17 mm
C	17 mm
Size (mm)	35x72x17
Width (mm)	17
Bearing number	1207
Bore Diameter (mm)	35
Outer Diameter (mm)	72

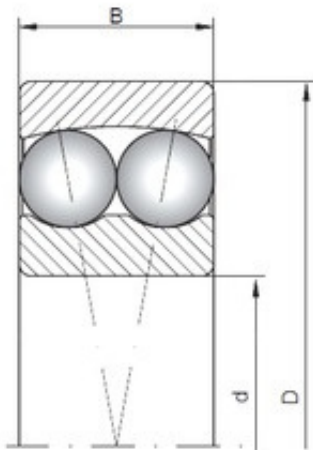

### Bearing No. 1206

D	62 mm
d	30 mm
B	16 mm
C	16 mm
Weight	0,22 Kg
Size (mm)	30x62x16
Width (mm)	16
Bearing number	1206
Bore Diameter (mm)	30
Outer Diameter (mm)	62
(Grease) Lubrication Speed	10000 r/min
Basic dynamic load rating (C)	15,6 kN
Basic static load rating (C0)	4,65 kN

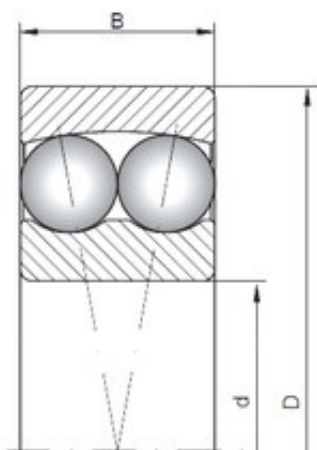

### Bearing No. 1205

D	52 mm
d	25 mm
B	15 mm
C	15 mm
Size (mm)	25x52x15
Width (mm)	15
Bearing number	1205
Bore Diameter (mm)	25
Outer Diameter (mm)	52

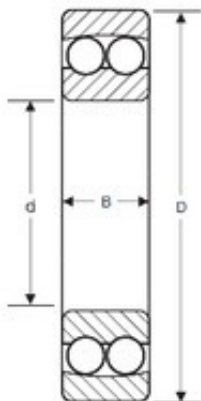

### Bearing No. 1204

D	47 mm
d	20 mm
B	14 mm
C	14 mm
Size (mm)	20x47x14
Width (mm)	14
Bearing number	1204
Bore Diameter (mm)	20
Outer Diameter (mm)	47

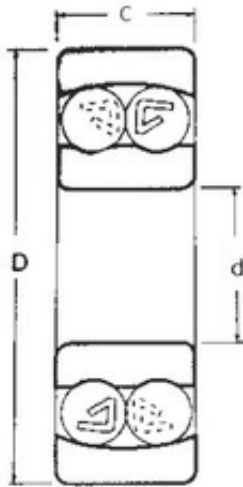

### Bearing No. 1203

D	40 mm
d	17 mm
B	12 mm
C	12 mm
Weight	0,073 Kg
Size (mm)	17x40x12
Width (mm)	12
Bearing number	1203
Bore Diameter (mm)	17
Outer Diameter (mm)	40
(Grease) Lubrication Speed	16000 r/min
Basic dynamic load rating (C)	7,9 kN
Basic static load rating (C0)	2 kN

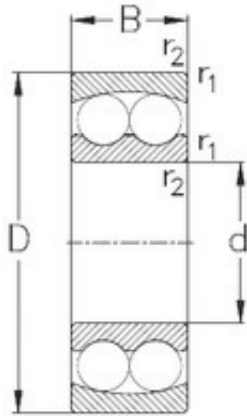

**Bearing No. 1202**

D	35 mm
d	15 mm
B	11 mm
C	11 mm
Weight	0,05 Kg
r1 min.	0,6 mm
r2 min.	0,6 mm
Size (mm)	15x35x11
Width (mm)	11
Bearing number	1202
Bore Diameter (mm)	15
Outer Diameter (mm)	35
Basic dynamic load rating (C)	7,4 kN
Basic static load rating (C0)	1,7 kN

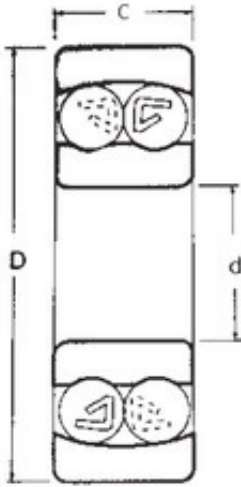

### Bearing No. 1201

D	32 mm
d	12 mm
B	10 mm
C	10 mm
Weight	0,04 Kg
Size (mm)	12x32x10
Width (mm)	10
Bearing number	1201
Bore Diameter (mm)	12
Outer Diameter (mm)	32
(Grease) Lubrication Speed	21000 r/min
Basic dynamic load rating (C)	5,6 kN
Basic static load rating (C0)	1,25 kN

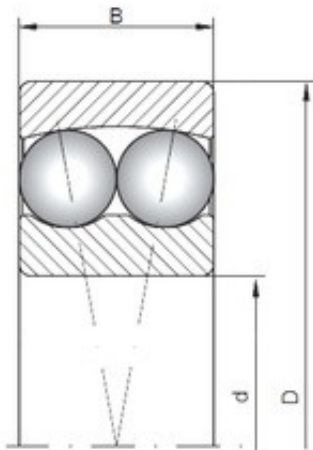

### Bearing No. 129

D	26 mm
d	9 mm
B	8 mm
C	8 mm
Weight	0,022 Kg
Size (mm)	9x26x8
Width (mm)	8
Bearing number	129
Bore Diameter (mm)	9
Outer Diameter (mm)	26
(Grease) Lubrication Speed	26000 r/min
Basic dynamic load rating (C)	3,9 kN
Basic static load rating (C0)	0,815 kN

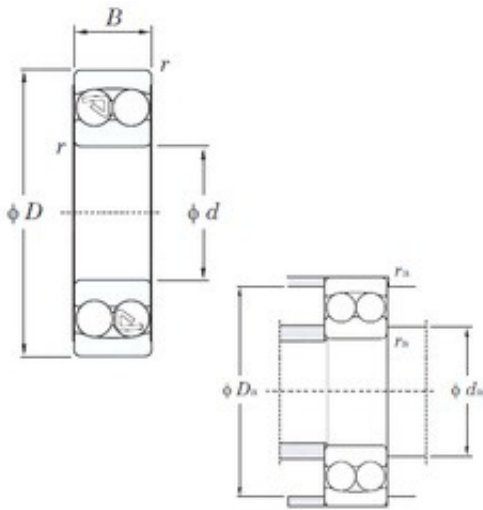

## Bearing No. 127

D	22 mm
d	7 mm
B	7 mm
C	7 mm
Weight	0.014 Kg
r min.	0.3 mm
da min.	9 mm
Da max.	20 mm
ra max.	0.3 mm
Size (mm)	7x22x7
Width (mm)	7
Bearing number	127
Bore Diameter (mm)	7
Outer Diameter (mm)	22
Calculation factor (e)	0.35
(Oil) Lubrication Speed	33000 r/min
Calculation factor (Y0)	1.91
Calculation factor (Y1)	1.82
(Grease) Lubrication Speed	27000 r/min
Basic dynamic load rating (C)	2.65 kN
Basic static load rating (C0)	0.56 kN

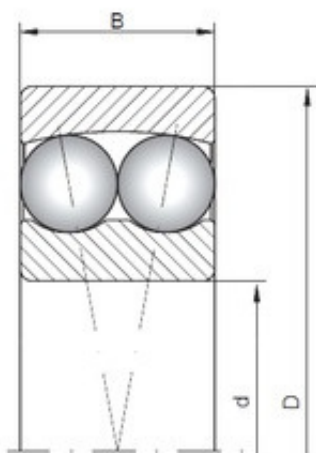

**Bearing No. 126**

D	19 mm
d	6 mm
B	6 mm
C	6 mm
Size (mm)	6x19x6
Width (mm)	6
Bearing number	126
Bore Diameter (mm)	6
Outer Diameter (mm)	19

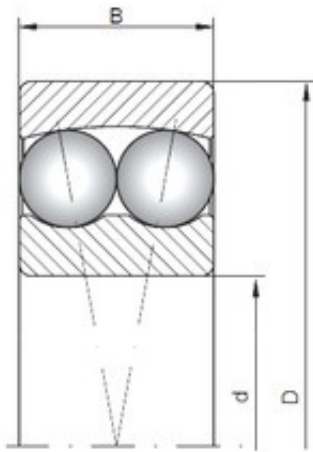

## Bearing No. 1309

D	100 mm
d	45 mm
B	25 mm
C	25 mm
Size (mm)	45x100x25
Width (mm)	25
Bearing number	1309
Bore Diameter (mm)	45
Outer Diameter (mm)	100

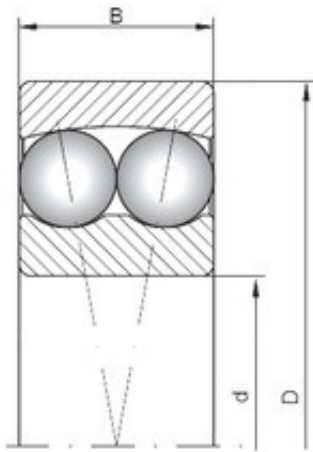

### Bearing No. 1308

D	90 mm
d	40 mm
B	23 mm
C	23 mm
Size (mm)	40x90x23
Width (mm)	23
Bearing number	1308
Bore Diameter (mm)	40
Outer Diameter (mm)	90

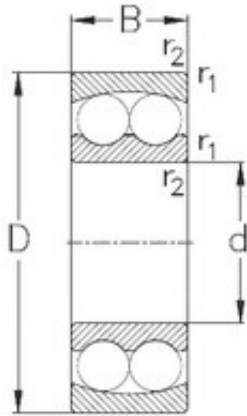

### Bearing No. 1307

D	80 mm
d	35 mm
B	21 mm
C	21 mm
Weight	0,54 Kg
r1 min.	1,5 mm
r2 min.	1,5 mm
Size (mm)	35x80x21
Width (mm)	21
Bearing number	1307
Bore Diameter (mm)	35
Outer Diameter (mm)	80
Basic dynamic load rating (C)	26,2 kN
Basic static load rating (C0)	8,5 kN

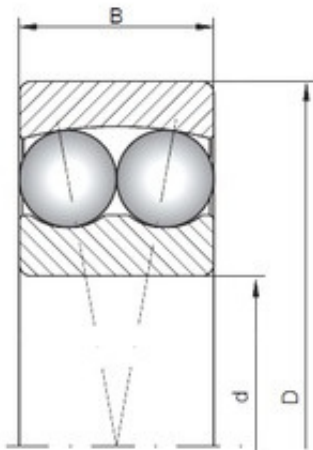

### Bearing No. 1306

D	72 mm
d	30 mm
B	19 mm
C	19 mm
Weight	0,39 Kg
Size (mm)	30x72x19
Width (mm)	19
Bearing number	1306
Bore Diameter (mm)	30
Outer Diameter (mm)	72
(Grease) Lubrication Speed	9000 r/min
Basic dynamic load rating (C)	22,5 kN
Basic static load rating (C0)	6,8 kN

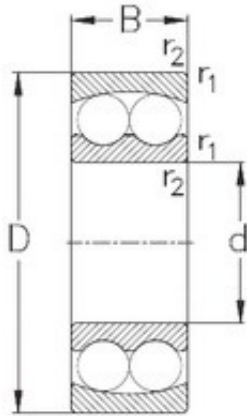

### Bearing No. 1305

D	62 mm
d	25 mm
B	17 mm
C	17 mm
Weight	0,28 Kg
r1 min.	1,1 mm
r2 min.	1,1 mm
Size (mm)	25x62x17
Width (mm)	17
Bearing number	1305
Bore Diameter (mm)	25
Outer Diameter (mm)	62
Basic dynamic load rating (C)	18,9 kN
Basic static load rating (C0)	5,5 kN

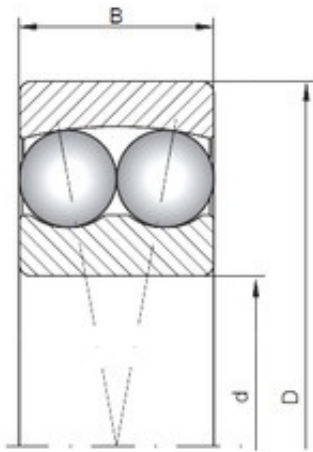

### Bearing No. 1304

D	52 mm
d	20 mm
B	15 mm
C	15 mm
Size (mm)	20x52x15
Width (mm)	15
Bearing number	1304
Bore Diameter (mm)	20
Outer Diameter (mm)	52

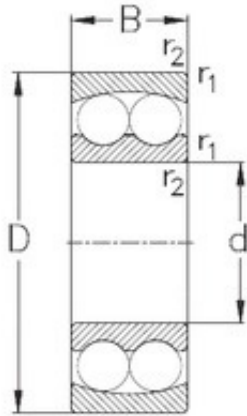

### Bearing No. 1303

D	47 mm
d	17 mm
B	14 mm
C	14 mm
Weight	0,14 Kg
r1 min.	1 mm
r2 min.	1 mm
Size (mm)	17x47x14
Width (mm)	14
Bearing number	1303
Bore Diameter (mm)	17
Outer Diameter (mm)	47
Basic dynamic load rating (C)	12,8 kN
Basic static load rating (C0)	3,4 kN

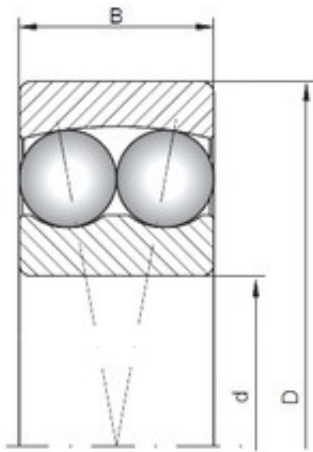

### Bearing No. 1302

D	42 mm
d	15 mm
B	13 mm
C	13 mm
Size (mm)	15x42x13
Width (mm)	13
Bearing number	1302
Bore Diameter (mm)	15
Outer Diameter (mm)	42

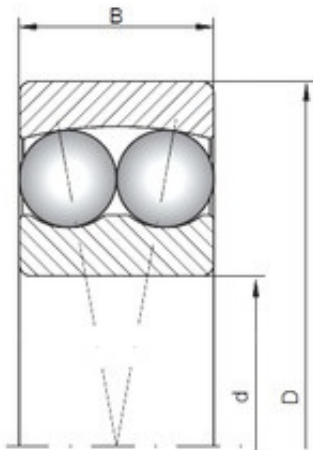

### Bearing No. 1301

D	37 mm
d	12 mm
B	12 mm
C	12 mm
Weight	0,067 Kg
Size (mm)	12x37x12
Width (mm)	12
Bearing number	1301
Bore Diameter (mm)	12
Outer Diameter (mm)	37
(Grease) Lubrication Speed	18000 r/min
Basic dynamic load rating (C)	9,36 kN
Basic static load rating (C0)	2,16 kN

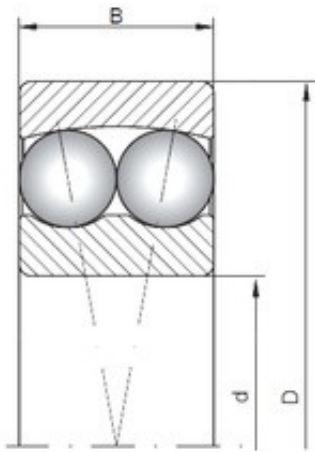

**Bearing No. 135**

D	19 mm
d	5 mm
B	6 mm
C	6 mm
Size (mm)	5x19x6
Width (mm)	6
Bearing number	135
Bore Diameter (mm)	5
Outer Diameter (mm)	19

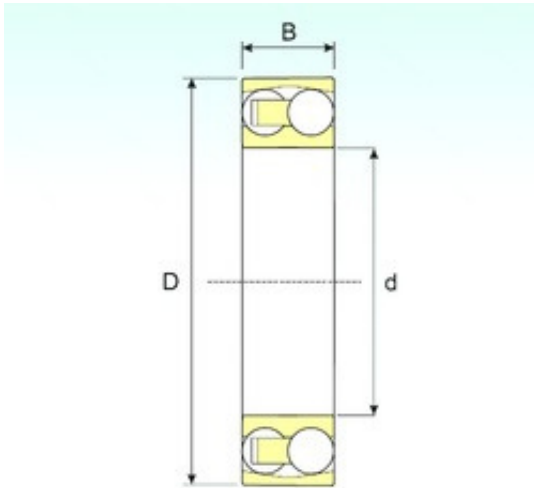

### Bearing No. 2310

D	110 mm
d	50 mm
B	40 mm
C	40 mm
Weight	1,65 Kg
Size (mm)	50x110x40
Width (mm)	40
Bearing number	2310
Bore Diameter (mm)	50
Outer Diameter (mm)	110
(Grease) Lubrication Speed	7267,5 r/min
Basic dynamic load rating (C)	62,43 kN
Basic static load rating (C0)	19,60 kN

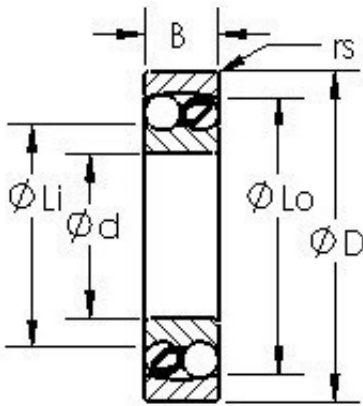

### Bearing No. 2309

Material	52100 Chrome steel (or equivalent)
Width (B)	36.0000
Precision	A1
Size (mm)	45x100x36
Weight (g)	1,200.00
Width (mm)	36
Bore Dia (d)	45.0000
Outer Dia (D)	100.0000
Bearing number	2309
Radius (min) (rs)	1.500
Bore Diameter (mm)	45
Standard Clearance	C0
Outer Diameter (mm)	100
Static Load Rating (Cor)	16,700
Dynamic Load Rating (Cr)	55,000
Max Speed (Oil) (X1000 RPM)	7,100
Max Speed (Grease) (X1000 RPM)	5,600
Max. Shaft Shoulder Dia. Inner (Li)	53.0
Min. Housing Shoulder Dia., Outer (Lo)	92.0
Bearing Type - double row self-aligning	double row selfaligning

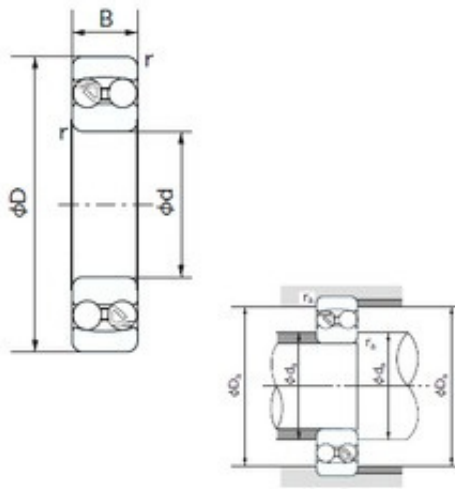

**Bearing No. 2308**

D	90 mm
d	40 mm
B	33 mm
C	33 mm
Weight	0.925 Kg
da min.	48 mm
Da max.	82 mm
ra max.	1.5 mm
r1 min.	1.5 mm
Size (mm)	40x90x33
Width (mm)	33
Bearing number	2308
Bore Diameter (mm)	40
Outer Diameter (mm)	90
Calculation factor (e)	0.43
(Oil) Lubrication Speed	7800 r/min
Calculation factor (Y0)	1.54
Calculation factor (Y1)	1.47
(Grease) Lubrication Speed	6200 r/min
Basic dynamic load rating (C)	44,9 kN
Basic static load rating (C0)	13,5 kN

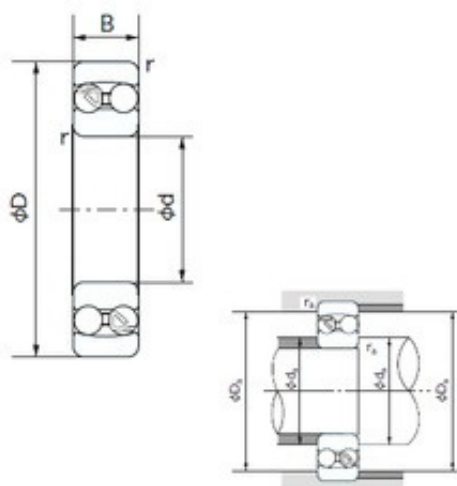

### Bearing No. 2307

D	80 mm
d	35 mm
B	31 mm
C	31 mm
Weight	0.675 Kg
da min.	43 mm
Da max.	72 mm
ra max.	1.5 mm
r1 min.	1.5 mm
Size (mm)	35x80x31
Width (mm)	31
Bearing number	2307
Bore Diameter (mm)	35
Outer Diameter (mm)	80
Calculation factor (e)	0.45
(Oil) Lubrication Speed	8800 r/min
Calculation factor (Y0)	1.46
Calculation factor (Y1)	1.39
(Grease) Lubrication Speed	7000 r/min
Basic dynamic load rating (C)	39,4 kN
Basic static load rating (C0)	11,3 kN

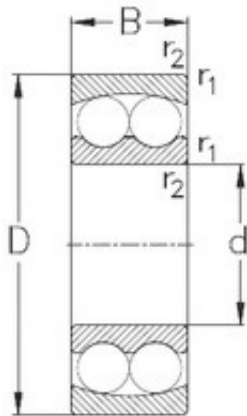

**Bearing No. 2306**

D	72 mm
d	30 mm
B	27 mm
C	27 mm
Weight	0,55 Kg
r1 min.	1,1 mm
r2 min.	1,1 mm
Size (mm)	30x72x27
Width (mm)	27
Bearing number	2306
Bore Diameter (mm)	30
Outer Diameter (mm)	72
Basic dynamic load rating (C)	31,4 kN
Basic static load rating (C0)	8,7 kN

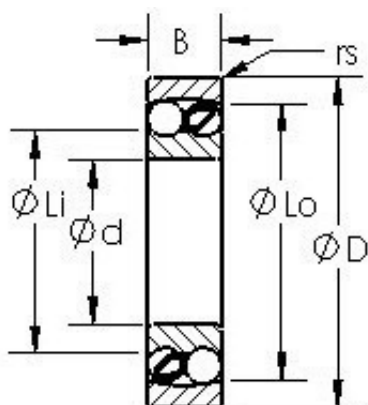

### Bearing No. 2305

Material	52100 Chrome steel (or equivalent)
Width (B)	24.0000
Precision	A1
Size (mm)	25x62x24
Weight (g)	319.00
Width (mm)	24
Bore Dia (d)	25.0000
Outer Dia (D)	62.0000
Bearing number	2305
Radius (min) (rs)	1.100
Bore Diameter (mm)	25
Standard Clearance	C0
Outer Diameter (mm)	62
Static Load Rating (Cor)	6,600
Dynamic Load Rating (Cr)	24,900
Max Speed (Oil) (X1000 RPM)	12,000
Max Speed (Grease) (X1000 RPM)	9,500
Max. Shaft Shoulder Dia. Inner (Li)	31.5
Min. Housing Shoulder Dia., Outer (Lo)	55.5
Bearing Type - double row self-aligning	double row self-aligning

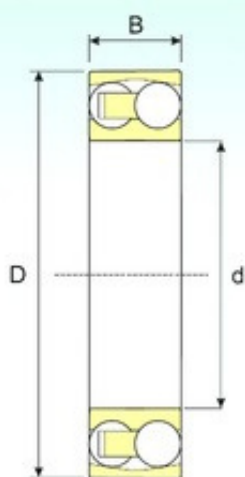

### Bearing No. 2303

D	47 mm
d	17 mm
B	19 mm
C	19 mm
Weight	0,16 Kg
Size (mm)	17x47x19
Width (mm)	19
Bearing number	2303
Bore Diameter (mm)	17
Outer Diameter (mm)	47
(Grease) Lubrication Speed	16830 r/min
Basic dynamic load rating (C)	14,31 kN
Basic static load rating (C0)	3,48 kN

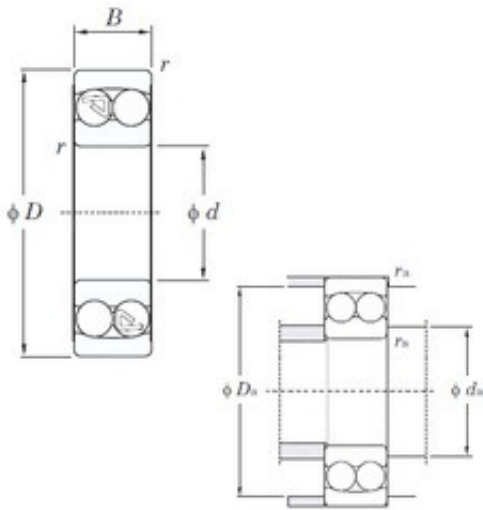

### Bearing No. 2301

D	37 mm
d	12 mm
B	17 mm
C	17 mm
Weight	0.095 Kg
r min.	1 mm
da min.	17 mm
Da max.	32 mm
ra max.	1 mm
Size (mm)	12x37x17
Width (mm)	17
Bearing number	2301
Bore Diameter (mm)	12
Outer Diameter (mm)	37
Calculation factor (e)	0.54
(Oil) Lubrication Speed	22000 r/min
Calculation factor (Y0)	1.23
Calculation factor (Y1)	1.17
(Grease) Lubrication Speed	16000 r/min
Basic dynamic load rating (C)	9.70 kN
Basic static load rating (C0)	2.30 kN

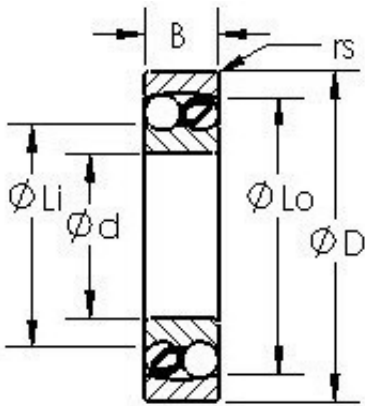

### Bearing No. 2312

Material	52100 Chrome steel (or equivalent)
Width (B)	46.0000
Precision	A1
Size (mm)	60x130x46
Weight (g)	2,570.00
Width (mm)	46
Bore Dia (d)	60.0000
Outer Dia (D)	130.0000
Bearing number	2312
Radius (min) (rs)	2.100
Bore Diameter (mm)	60
Standard Clearance	C0
Outer Diameter (mm)	130
Static Load Rating (Cor)	28,300
Dynamic Load Rating (Cr)	88,500
Max Speed (Oil) (X1000 RPM)	5,300
Max Speed (Grease) (X1000 RPM)	4,300
Max. Shaft Shoulder Dia. Inner (Li)	71.0
Min. Housing Shoulder Dia., Outer (Lo)	119.0
Bearing Type - double row self-aligning	double row self-aligning

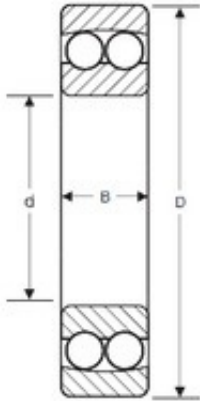

### Bearing No. 2311

D	120 mm
d	55 mm
B	43 mm
C	43 mm
Size (mm)	55x120x43
Width (mm)	43
Bearing number	2311
Bore Diameter (mm)	55
Outer Diameter (mm)	120

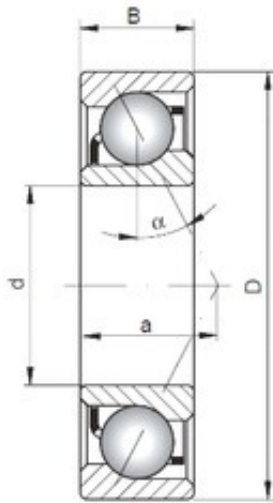

**Bearing No. 7211 B**

D	100 mm
d	55 mm
B	21 mm
C	21 mm
a	43,6 mm
Weight	0,68 Kg
Size (mm)	55x100x21
Width (mm)	21
Bearing number	7211 B
Angle (?)	40 °
Bore Diameter (mm)	55
Outer Diameter (mm)	100
(Grease) Lubrication Speed	5700 r/min
Basic dynamic load rating (C)	44,1 kN
Basic static load rating (C0)	33,8 kN

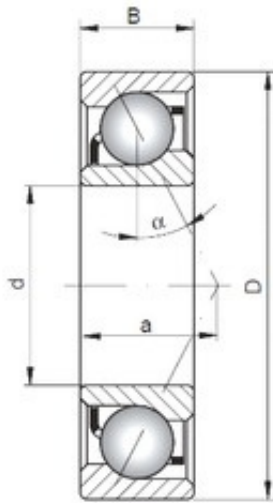

**Bearing No. 7210 B**

D	90 mm
d	50 mm
B	20 mm
C	20 mm
a	39,6 mm
Weight	0,51 Kg
Size (mm)	50x90x20
Width (mm)	20
Bearing number	7210 B
Angle (?)	40°
Bore Diameter (mm)	50
Outer Diameter (mm)	90
(Grease) Lubrication Speed	6400 r/min
Basic dynamic load rating (C)	35,7 kN
Basic static load rating (C0)	26,7 kN

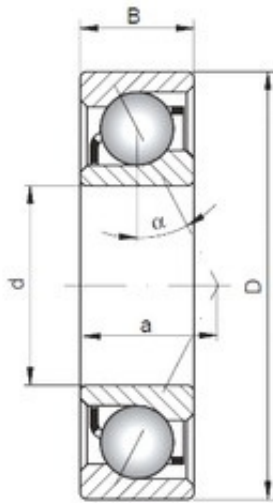

### Bearing No. 7209 B

D	85 mm
d	45 mm
B	19 mm
C	19 mm
a	36,4 mm
Weight	0,46 Kg
Size (mm)	45x85x19
Width (mm)	19
Bearing number	7209 B
Angle (?)	40 °
Bore Diameter (mm)	45
Outer Diameter (mm)	85
(Grease) Lubrication Speed	7000 r/min
Basic dynamic load rating (C)	34,3 kN
Basic static load rating (C0)	24,3 kN

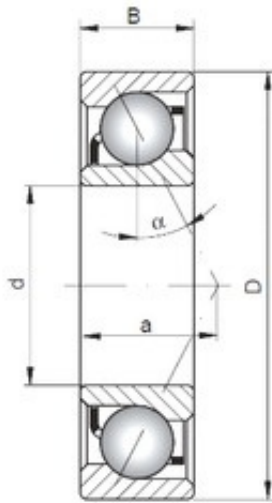

**Bearing No. 7208 B**

D	80 mm
d	40 mm
B	18 mm
C	18 mm
a	34,2 mm
Weight	0,402 Kg
Size (mm)	40x80x18
Width (mm)	18
Bearing number	7208 B
Angle (?)	40 °
Bore Diameter (mm)	40
Outer Diameter (mm)	80
(Grease) Lubrication Speed	7500 r/min
Basic dynamic load rating (C)	30,6 kN
Basic static load rating (C0)	21,3 kN

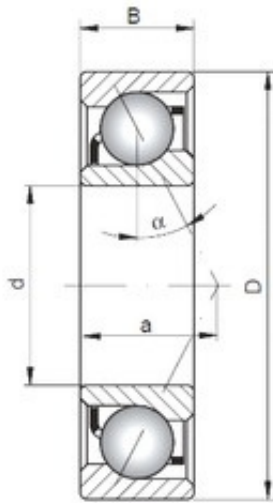

**Bearing No. 7207 B**

D	72 mm
d	35 mm
B	17 mm
C	17 mm
a	31,4 mm
Weight	0,313 Kg
Size (mm)	35x72x17
Width (mm)	17
Bearing number	7207 B
Angle (?)	40°
Bore Diameter (mm)	35
Outer Diameter (mm)	72
(Grease) Lubrication Speed	8300 r/min
Basic dynamic load rating (C)	25,6 kN
Basic static load rating (C0)	17 kN

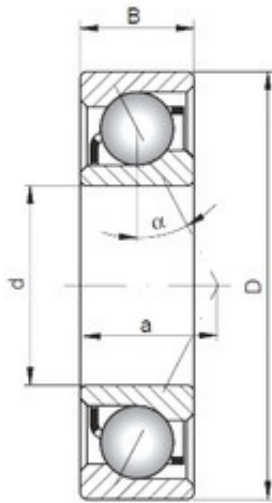

**Bearing No. 7206 B**

D	62 mm
d	30 mm
B	16 mm
C	16 mm
a	27,6 mm
Weight	0,217 Kg
Size (mm)	30x62x16
Width (mm)	16
Bearing number	7206 B
Angle (?)	40°
Bore Diameter (mm)	30
Outer Diameter (mm)	62
(Grease) Lubrication Speed	9600 r/min
Basic dynamic load rating (C)	19,4 kN
Basic static load rating (C0)	12,5 kN

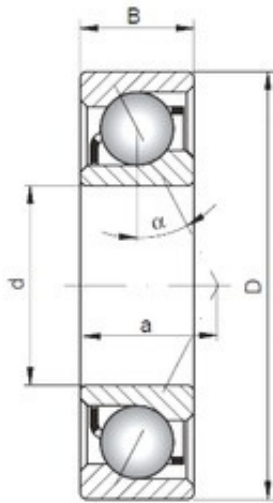

**Bearing No. 7205 B**

D	52 mm
d	25 mm
B	15 mm
C	15 mm
a	23,9 mm
Weight	0,139 Kg
Size (mm)	25x52x15
Width (mm)	15
Bearing number	7205 B
Angle (?)	40 °
Bore Diameter (mm)	25
Outer Diameter (mm)	52
(Grease) Lubrication Speed	12000 r/min
Basic dynamic load rating (C)	14 kN
Basic static load rating (C0)	8,7 kN

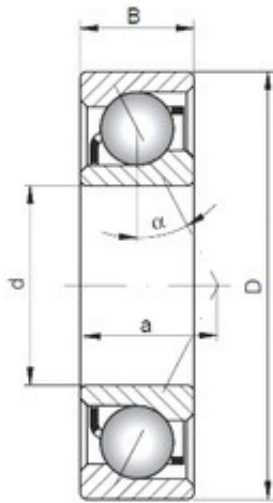

**Bearing No. 7204 B**

D	47 mm
d	20 mm
B	14 mm
C	14 mm
a	21,5 mm
Weight	0,113 Kg
Size (mm)	20x47x14
Width (mm)	14
Bearing number	7204 B
Angle (?)	40 °
Bore Diameter (mm)	20
Outer Diameter (mm)	47
(Grease) Lubrication Speed	13000 r/min
Basic dynamic load rating (C)	13,3 kN
Basic static load rating (C0)	7,7 kN

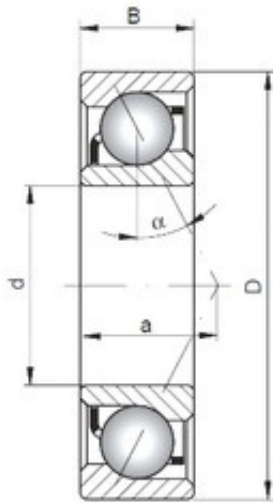

**Bearing No. 7203 B**

D	40 mm
d	17 mm
B	12 mm
C	12 mm
a	18,2 mm
Weight	0,069 Kg
Size (mm)	17x40x12
Width (mm)	12
Bearing number	7203 B
Angle (?)	40 °
Bore Diameter (mm)	17
Outer Diameter (mm)	40
(Grease) Lubrication Speed	16000 r/min
Basic dynamic load rating (C)	9,35 kN
Basic static load rating (C0)	5,05 kN

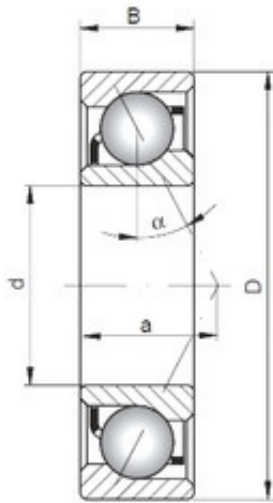

**Bearing No. 7202 B**

D	35 mm
d	15 mm
B	11 mm
C	11 mm
a	16,2 mm
Weight	0,048 Kg
Size (mm)	15x35x11
Width (mm)	11
Bearing number	7202 B
Angle (?)	40 °
Bore Diameter (mm)	15
Outer Diameter (mm)	35
(Grease) Lubrication Speed	18000 r/min
Basic dynamic load rating (C)	7,45 kN
Basic static load rating (C0)	3,95 kN

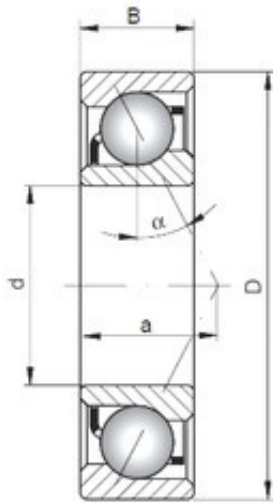

**Bearing No. 7200 B**

D	30 mm
d	10 mm
B	9 mm
C	9 mm
a	13,1 mm
Weight	0,032 Kg
Size (mm)	10x30x9
Width (mm)	9
Bearing number	7200 B
Angle (?)	40 °
Bore Diameter (mm)	10
Outer Diameter (mm)	30
(Grease) Lubrication Speed	22000 r/min
Basic dynamic load rating (C)	4,3 kN
Basic static load rating (C0)	2 kN

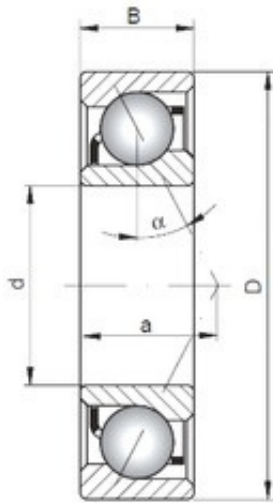

**Bearing No. 7201 B**

D	32 mm
d	12 mm
B	10 mm
C	10 mm
a	14,2 mm
Weight	0,039 Kg
Size (mm)	12x32x10
Width (mm)	10
Bearing number	7201 B
Angle (?)	40 °
Bore Diameter (mm)	12
Outer Diameter (mm)	32
(Grease) Lubrication Speed	20000 r/min
Basic dynamic load rating (C)	6,95 kN
Basic static load rating (C0)	3,4 kN

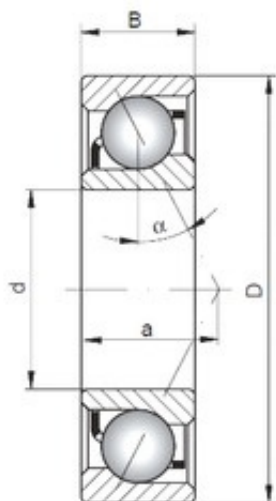

**Bearing No. 7416 B**

D	200 mm
d	80 mm
B	48 mm
C	48 mm
a	83,6 mm
Size (mm)	80x200x48
Width (mm)	48
Bearing number	7416 B
Angle (?)	40 °
Bore Diameter (mm)	80
Outer Diameter (mm)	200

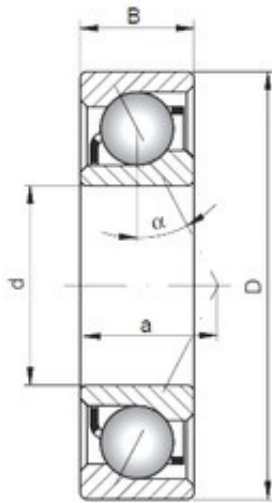

**Bearing No. 7415 B**

D	190 mm
d	75 mm
B	45 mm
C	45 mm
a	78,9 mm
Size (mm)	75x190x45
Width (mm)	45
Bearing number	7415 B
Angle (?)	40 °
Bore Diameter (mm)	75
Outer Diameter (mm)	190

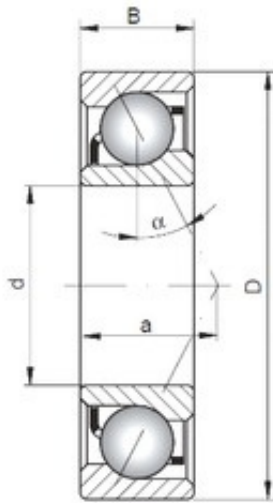

**Bearing No. 7414 B**

D	180 mm
d	70 mm
B	42 mm
C	42 mm
a	74,2 mm
Size (mm)	70x180x42
Width (mm)	42
Bearing number	7414 B
Angle (?)	40 °
Bore Diameter (mm)	70
Outer Diameter (mm)	180

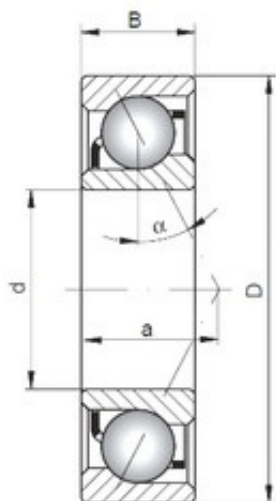

**Bearing No. 7413 B**

D	160 mm
d	65 mm
B	37 mm
C	37 mm
a	66,3 mm
Size (mm)	65x160x37
Width (mm)	37
Bearing number	7413 B
Angle (?)	40 °
Bore Diameter (mm)	65
Outer Diameter (mm)	160

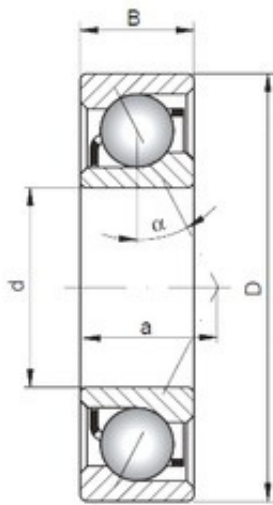

**Bearing No. 7412 B**

D	150 mm
d	60 mm
B	35 mm
C	35 mm
a	62,6 mm
Size (mm)	60x150x35
Width (mm)	35
Bearing number	7412 B
Angle (?)	40 °
Bore Diameter (mm)	60
Outer Diameter (mm)	150

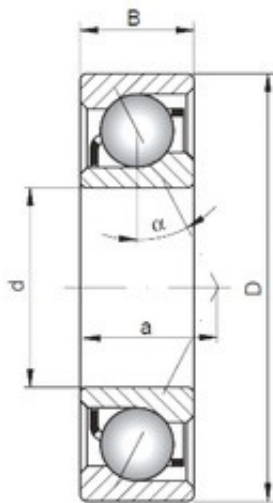

**Bearing No. 7411 B**

D	140 mm
d	55 mm
B	33 mm
C	33 mm
a	57,8 mm
Size (mm)	55x140x33
Width (mm)	33
Bearing number	7411 B
Angle (?)	40 °
Bore Diameter (mm)	55
Outer Diameter (mm)	140

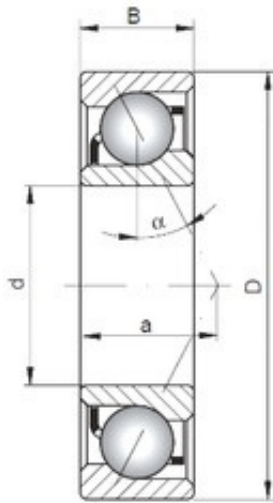

**Bearing No. 7410 B**

D	130 mm
d	50 mm
B	31 mm
C	31 mm
a	53,5 mm
Size (mm)	50x130x31
Width (mm)	31
Bearing number	7410 B
Angle (?)	40 °
Bore Diameter (mm)	50
Outer Diameter (mm)	130

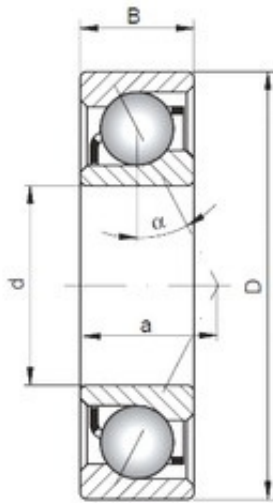

**Bearing No. 7409 B**

D	120 mm
d	45 mm
B	29 mm
C	29 mm
a	49,5 mm
Size (mm)	45x120x29
Width (mm)	29
Bearing number	7409 B
Angle (?)	40 °
Bore Diameter (mm)	45
Outer Diameter (mm)	120

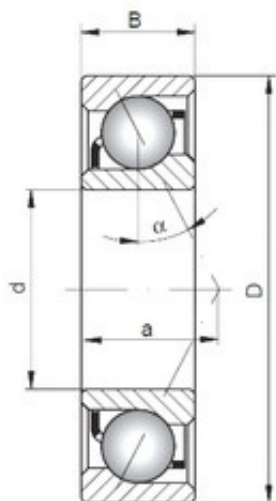

**Bearing No. 7408 B**

D	110 mm
d	40 mm
B	27 mm
C	27 mm
a	45,4 mm
Size (mm)	40x110x27
Width (mm)	27
Bearing number	7408 B
Angle (?)	40 °
Bore Diameter (mm)	40
Outer Diameter (mm)	110

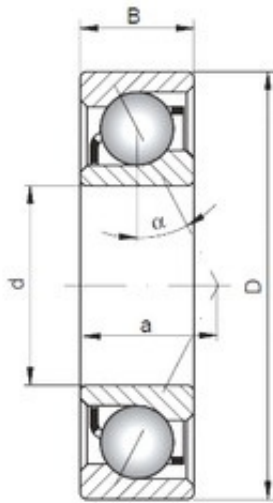

**Bearing No. 7407 B**

D	100 mm
d	35 mm
B	25 mm
C	25 mm
a	41,7 mm
Weight	0,95 Kg
Size (mm)	35x100x25
Width (mm)	25
Bearing number	7407 B
Angle (?)	40 °
Bore Diameter (mm)	35
Outer Diameter (mm)	100
(Grease) Lubrication Speed	5700 r/min
Basic dynamic load rating (C)	56,2 kN
Basic static load rating (C0)	34,3 kN

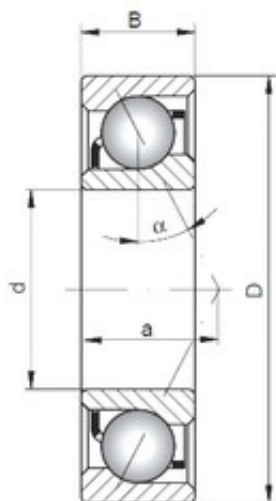

**Bearing No. 7406 B**

D	90 mm
d	30 mm
B	23 mm
C	23 mm
a	37,3 mm
Size (mm)	30x90x23
Width (mm)	23
Bearing number	7406 B
Angle (?)	40 °
Bore Diameter (mm)	30
Outer Diameter (mm)	90

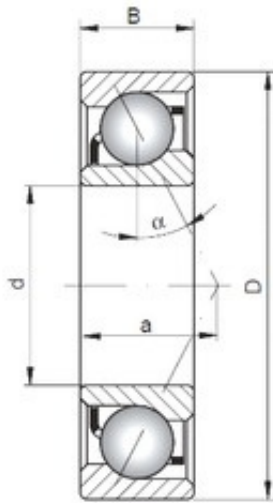

**Bearing No. 7405 B**

D	80 mm
d	25 mm
B	21 mm
C	21 mm
a	33,6 mm
Weight	0,527 Kg
Size (mm)	25x80x21
Width (mm)	21
Bearing number	7405 B
Angle (?)	40 °
Bore Diameter (mm)	25
Outer Diameter (mm)	80
(Grease) Lubrication Speed	7300 r/min
Basic dynamic load rating (C)	36,9 kN
Basic static load rating (C0)	21,5 kN

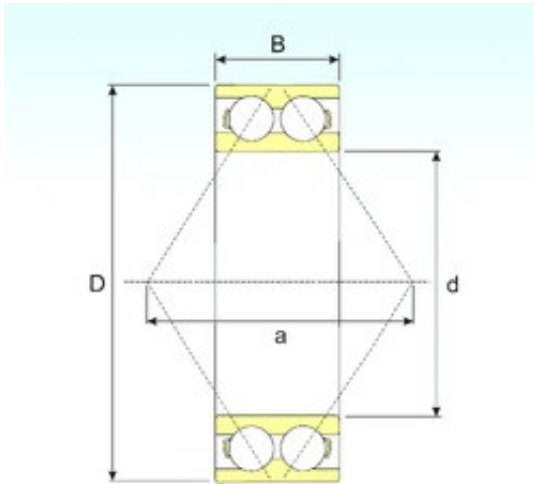

### Bearing No. 3210

D	90 mm
d	50 mm
B	30,2 mm
C	30,2 mm
r min.	1,1 mm
Weight	0,76 Kg
Size (mm)	50x90x30.2
Width (mm)	30,2
Bearing number	3210
Bore Diameter (mm)	50
Outer Diameter (mm)	90
(Grease) Lubrication Speed	4300 r/min
Basic dynamic load rating (C)	45,1 kN
Basic static load rating (C0)	52,1 kN

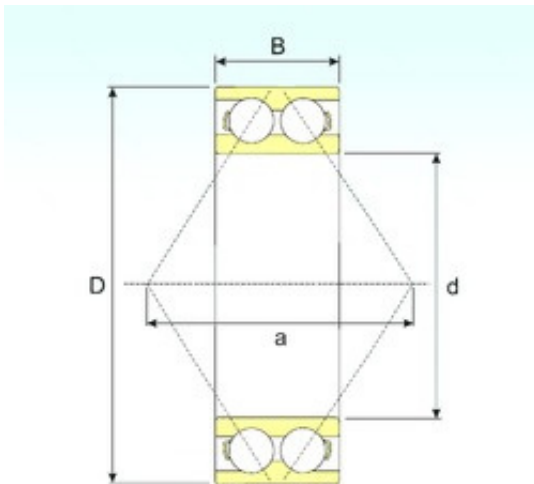

### Bearing No. 3209

D	85 mm
d	45 mm
B	30,2 mm
C	30,2 mm
r min.	1,1 mm
Weight	0,71 Kg
Size (mm)	45x85x30.2
Width (mm)	30,2
Bearing number	3209
Bore Diameter (mm)	45
Outer Diameter (mm)	85
(Grease) Lubrication Speed	4600 r/min
Basic dynamic load rating (C)	45,4 kN
Basic static load rating (C0)	51,4 kN

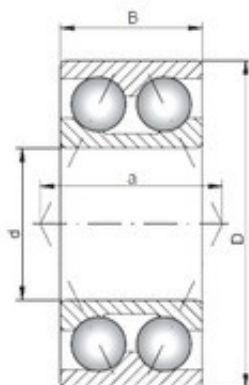

### Bearing No. 3208

D	80 mm
d	40 mm
C	30,2 mm
a	38,3 mm
B1	30,2 mm
Size (mm)	40x80x30.2
Width (mm)	30,2
Bearing number	3208
Bore Diameter (mm)	40
Outer Diameter (mm)	80

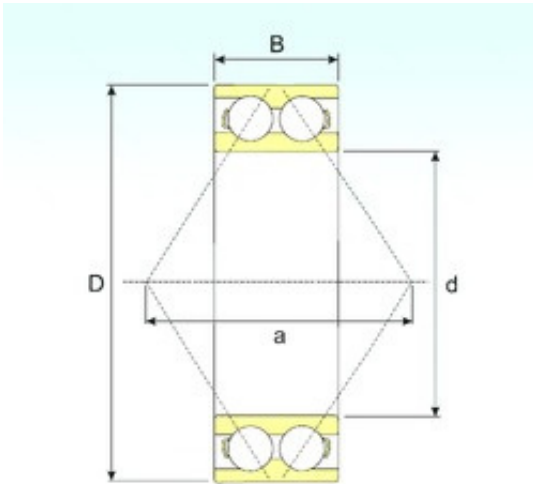

### Bearing No. 3207

D	72 mm
d	35 mm
B	27 mm
C	27 mm
r min.	1,1 mm
Weight	0,48 Kg
Size (mm)	35x72x27
Width (mm)	27
Bearing number	3207
Bore Diameter (mm)	35
Outer Diameter (mm)	72
(Grease) Lubrication Speed	5600 r/min
Basic dynamic load rating (C)	36,8 kN
Basic static load rating (C0)	37,5 kN

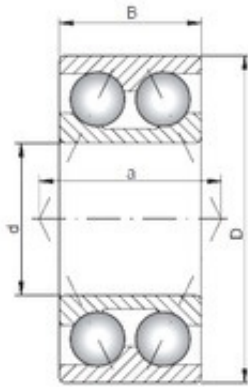

### Bearing No. 3206

D	62 mm
d	30 mm
C	23,8 mm
a	28,9 mm
B1	23,8 mm
Size (mm)	30x62x23.8
Width (mm)	23,8
Bearing number	3206
Bore Diameter (mm)	30
Outer Diameter (mm)	62

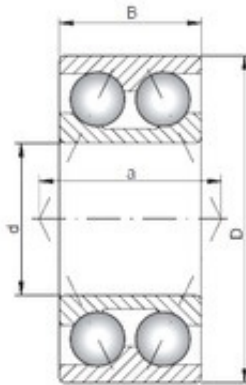

### Bearing No. 3205

D	52 mm
d	25 mm
C	20,6 mm
a	24 mm
B1	20,6 mm
Weight	0,18 Kg
Size (mm)	25x52x20.6
Width (mm)	20,6
Bearing number	3205
Bore Diameter (mm)	25
Outer Diameter (mm)	52
(Grease) Lubrication Speed	8000 r/min
Basic dynamic load rating (C)	20,3 kN
Basic static load rating (C0)	14 kN

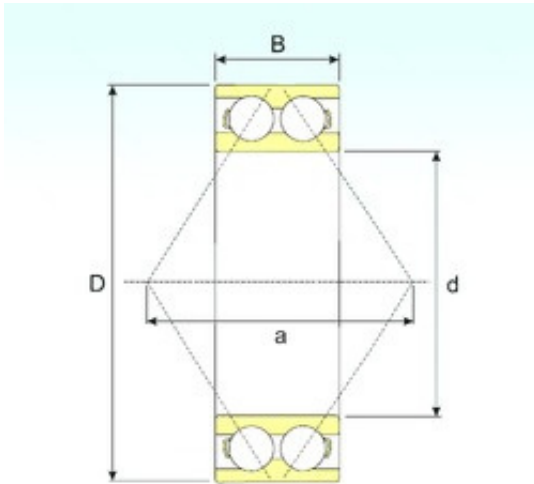

### Bearing No. 3204

D	47 mm
d	20 mm
B	20,6 mm
C	20,6 mm
r min.	1 mm
Weight	0,17 Kg
Size (mm)	20x47x20.6
Width (mm)	20,6
Bearing number	3204
Bore Diameter (mm)	20
Outer Diameter (mm)	47
(Grease) Lubrication Speed	9000 r/min
Basic dynamic load rating (C)	17,2 kN
Basic static load rating (C0)	15 kN

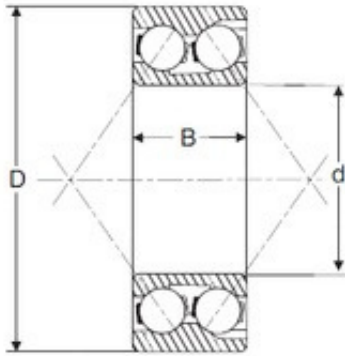

### Bearing No. 3203

D	40 mm
d	17 mm
B	17,5 mm
C	17,5 mm
Size (mm)	17x40x17.5
Width (mm)	17,5
Bearing number	3203
Bore Diameter (mm)	17
Outer Diameter (mm)	40

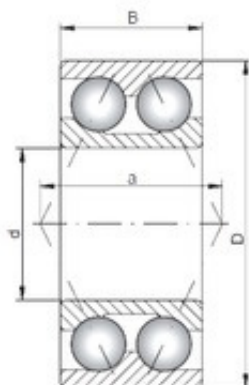

### Bearing No. 3202

D	35 mm
d	15 mm
C	15,9 mm
a	16,5 mm
B1	15,9 mm
Size (mm)	15x35x15.9
Width (mm)	15,9
Bearing number	3202
Bore Diameter (mm)	15
Outer Diameter (mm)	35

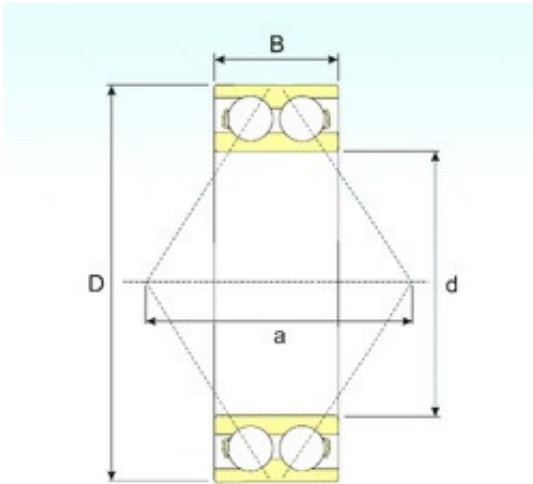

### Bearing No. 3201

D	32 mm
d	12 mm
B	15,9 mm
C	15,9 mm
r min.	0,6 mm
Weight	0,063 Kg
Size (mm)	12x32x15.9
Width (mm)	15,9
Bearing number	3201
Bore Diameter (mm)	12
Outer Diameter (mm)	32
(Grease) Lubrication Speed	14000 r/min
Basic dynamic load rating (C)	9,7 kN
Basic static load rating (C0)	7,15 kN

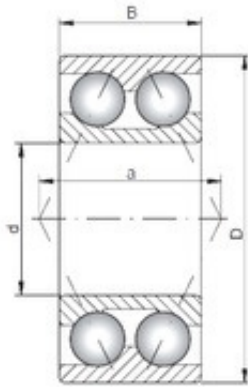

### Bearing No. 3200

D	30 mm
d	10 mm
C	14 mm
a	13,3 mm
B1	14 mm
Size (mm)	10x30x14
Width (mm)	14
Bearing number	3200
Bore Diameter (mm)	10
Outer Diameter (mm)	30

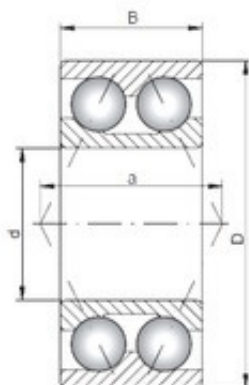

### Bearing No. 3315

D	160 mm
d	75 mm
C	68,3 mm
a	84,3 mm
B1	68,3 mm
Size (mm)	75x160x68.3
Width (mm)	68,3
Bearing number	3315
Bore Diameter (mm)	75
Outer Diameter (mm)	160

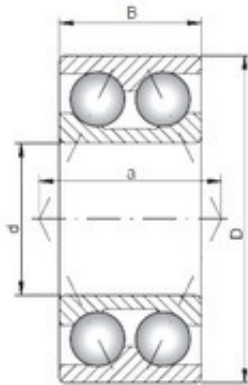

## Bearing No. 3314

D	150 mm
d	70 mm
C	63,5 mm
a	72,5 mm
B1	63,5 mm
Size (mm)	70x150x63.5
Width (mm)	63,5
Bearing number	3314
Bore Diameter (mm)	70
Outer Diameter (mm)	150

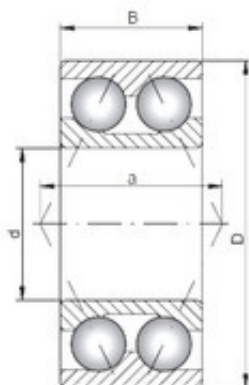

### Bearing No. 3313

D	140 mm
d	65 mm
C	58,7 mm
a	69,3 mm
B1	58,7 mm
Size (mm)	65x140x58.7
Width (mm)	58,7
Bearing number	3313
Bore Diameter (mm)	65
Outer Diameter (mm)	140

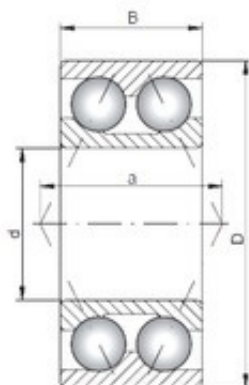

### Bearing No. 3312

D	130 mm
d	60 mm
C	54 mm
a	62,9 mm
B1	54 mm
Size (mm)	60x130x54
Width (mm)	54
Bearing number	3312
Bore Diameter (mm)	60
Outer Diameter (mm)	130

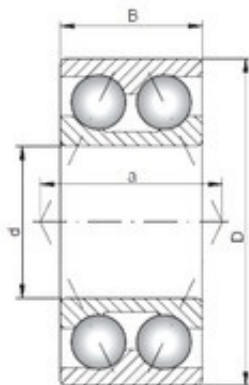

### Bearing No. 3310

D	110 mm
d	50 mm
C	44,4 mm
a	53,5 mm
B1	44,4 mm
Size (mm)	50x110x44.4
Width (mm)	44,4
Bearing number	3310
Bore Diameter (mm)	50
Outer Diameter (mm)	110

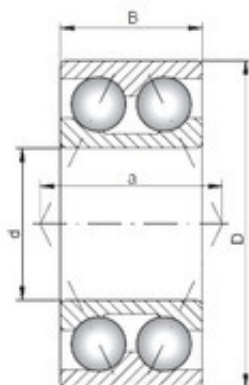

### Bearing No. 3308

D	90 mm
d	40 mm
C	36,5 mm
a	43,7 mm
B1	36,5 mm
Size (mm)	40x90x36.5
Width (mm)	36,5
Bearing number	3308
Bore Diameter (mm)	40
Outer Diameter (mm)	90

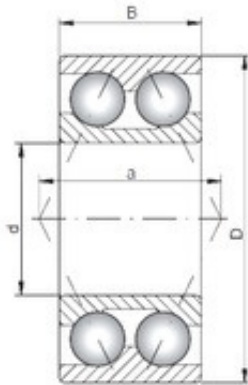

### Bearing No. 3309

D	100 mm
d	45 mm
C	39,7 mm
a	48,6 mm
B1	39,7 mm
Size (mm)	45x100x39.7
Width (mm)	39,7
Bearing number	3309
Bore Diameter (mm)	45
Outer Diameter (mm)	100

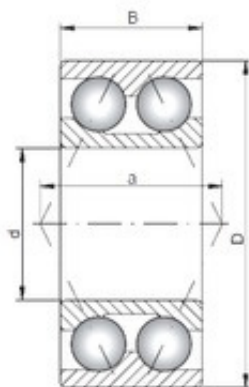

## Bearing No. 3318

D	190 mm
d	90 mm
C	73 mm
a	98 mm
B1	73 mm
Size (mm)	90x190x73
Width (mm)	73
Bearing number	3318
Bore Diameter (mm)	90
Outer Diameter (mm)	190

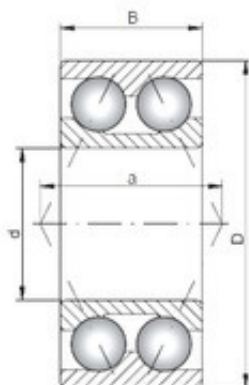

### Bearing No. 3317

D	180 mm
d	85 mm
C	73 mm
a	92 mm
B1	73 mm
Size (mm)	85x180x73
Width (mm)	73
Bearing number	3317
Bore Diameter (mm)	85
Outer Diameter (mm)	180

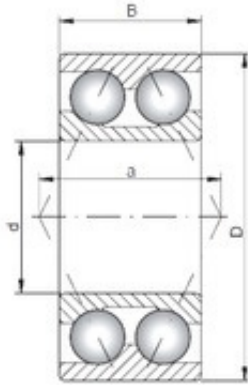

### Bearing No. 3316

D	170 mm
d	80 mm
C	68,3 mm
a	88,6 mm
B1	68,3 mm
Weight	6,95 Kg
Size (mm)	80x170x68.3
Width (mm)	68,3
Bearing number	3316
Bore Diameter (mm)	80
Outer Diameter (mm)	170
(Grease) Lubrication Speed	2400 r/min
Basic dynamic load rating (C)	176 kN
Basic static load rating (C0)	212 kN

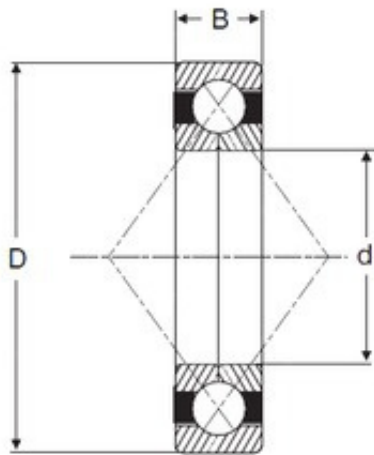

Bearing No. QJ 208

D	80 mm
d	40 mm
B	18 mm
C	18 mm
Size (mm)	40x80x18
Width (mm)	18
Bearing number	QJ 208
Bore Diameter (mm)	40
Outer Diameter (mm)	80

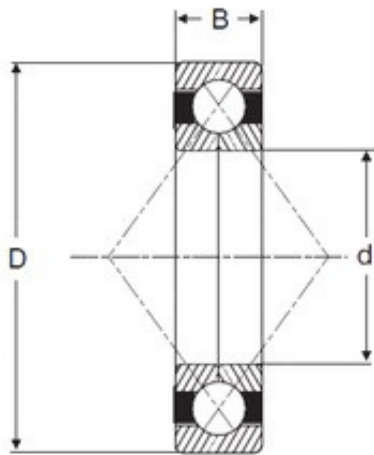

Bearing No. QJ 207

D	72 mm
d	35 mm
B	17 mm
C	17 mm
Size (mm)	35x72x17
Width (mm)	17
Bearing number	QJ 207
Bore Diameter (mm)	35
Outer Diameter (mm)	72

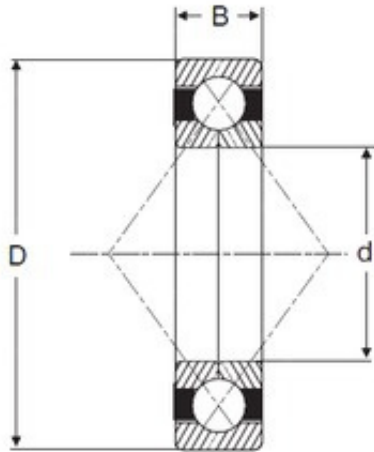

Bearing No. QJ 206

D	62 mm
d	30 mm
B	16 mm
C	16 mm
Size (mm)	30x62x16
Width (mm)	16
Bearing number	QJ 206
Bore Diameter (mm)	30
Outer Diameter (mm)	62

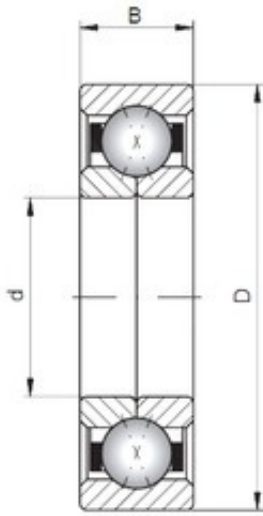

### Bearing No. QJ205

D	52 mm
d	25 mm
C	15 mm
B1	15 mm
Weight	0,16 Kg
Size (mm)	25x52x15
Width (mm)	15
Bearing number	QJ205
Bore Diameter (mm)	25
Outer Diameter (mm)	52
(Grease) Lubrication Speed	9750 r/min
Basic dynamic load rating (C)	25,1 kN
Basic static load rating (C0)	20 kN

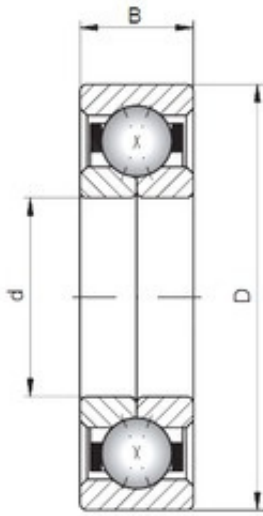

### Bearing No. QJ203

D	40 mm
d	17 mm
C	12 mm
B1	12 mm
Size (mm)	17x40x12
Width (mm)	12
Bearing number	QJ203
Bore Diameter (mm)	17
Outer Diameter (mm)	40

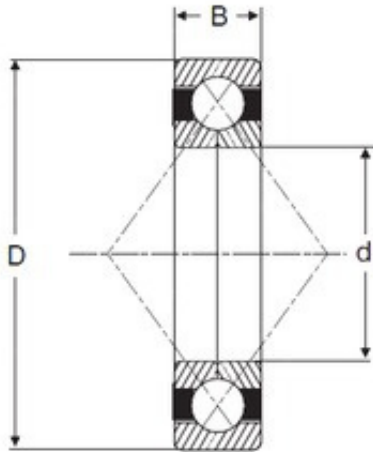

**Bearing No. QJ 226 N2**

D	230 mm
d	130 mm
B	40 mm
C	40 mm
Size (mm)	130x230x40
Width (mm)	40
Bearing number	QJ 226 N2
Bore Diameter (mm)	130
Outer Diameter (mm)	230

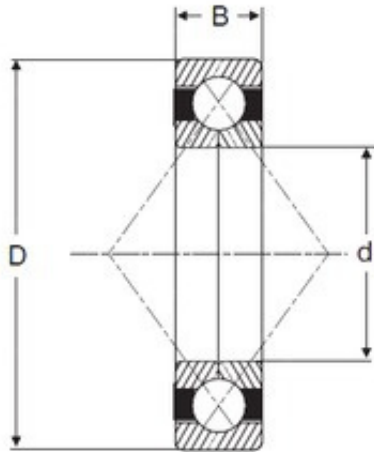

Bearing No. QJ 224 N2

D	215 mm
d	120 mm
B	40 mm
C	40 mm
Size (mm)	120x215x40
Width (mm)	40
Bearing number	QJ 224 N2
Bore Diameter (mm)	120
Outer Diameter (mm)	215

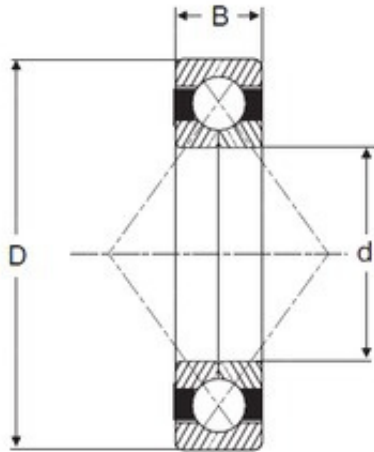

Bearing No. QJ 328 N2

D	300 mm
d	140 mm
B	62 mm
C	62 mm
Size (mm)	140x300x62
Width (mm)	62
Bearing number	QJ 328 N2
Bore Diameter (mm)	140
Outer Diameter (mm)	300

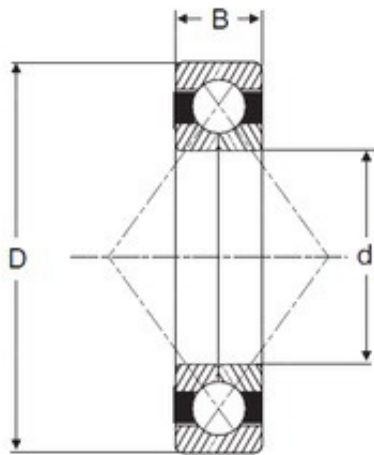

**Bearing No. QJ 316 N2**

D	170 mm
d	80 mm
B	39 mm
C	39 mm
Size (mm)	80x170x39
Width (mm)	39
Bearing number	QJ 316 N2
Bore Diameter (mm)	80
Outer Diameter (mm)	170

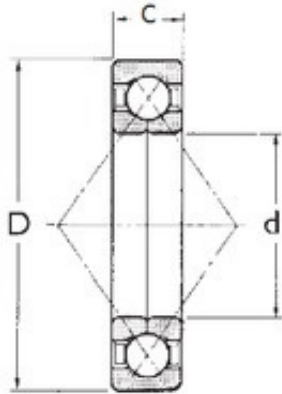

### Bearing No. QJ312

D	130 mm
d	60 mm
B	31 mm
C	31 mm
Weight	2,18 Kg
Size (mm)	60x130x31
Width (mm)	31
Bearing number	QJ312
Bore Diameter (mm)	60
Outer Diameter (mm)	130
(Grease) Lubrication Speed	4200 r/min
Basic dynamic load rating (C)	97 kN
Basic static load rating (C0)	188 kN

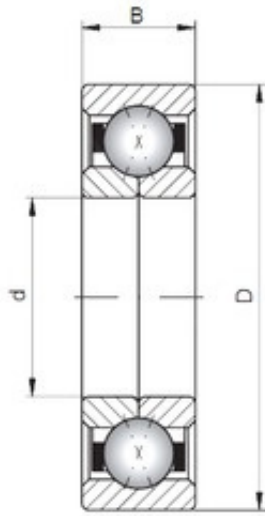

### Bearing No. QJ303

D	47 mm
d	17 mm
C	14 mm
B1	14 mm
Size (mm)	17x47x14
Width (mm)	14
Bearing number	QJ303
Bore Diameter (mm)	17
Outer Diameter (mm)	47

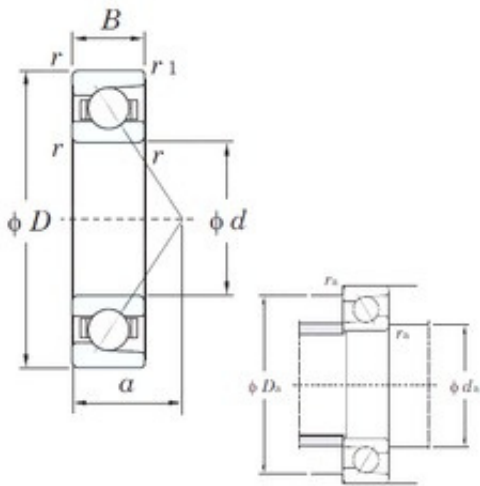

## Bearing No. 7010

D	80 mm
d	50 mm
B	16 mm
C	16 mm
a	26.9 mm
Weight	0.290 Kg
r min.	1 mm
Da max.	74.5 mm
ra max.	1 mm
r1 min.	0.6 mm
da min.	55.5 mm
Size (mm)	50x80x16
Width (mm)	16
Bearing number	7010
Angle (?)	30 °
Bore Diameter (mm)	50
Outer Diameter (mm)	80
(Grease) Lubrication Speed	9200 r/min

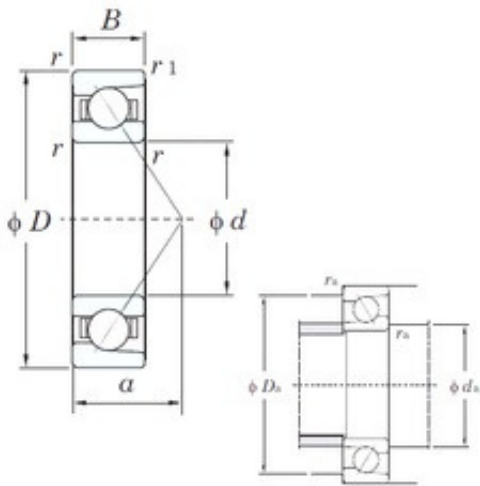

## Bearing No. 7009

D	75 mm
d	45 mm
B	16 mm
C	16 mm
a	25.3 mm
Weight	0.260 Kg
r min.	1 mm
Da max.	69.5 mm
ra max.	1 mm
r1 min.	0.6 mm
da min.	50.5 mm
Size (mm)	45x75x16
Width (mm)	16
Bearing number	7009
Angle (?)	30 °
Bore Diameter (mm)	45
Outer Diameter (mm)	75
(Grease) Lubrication Speed	10000 r/min

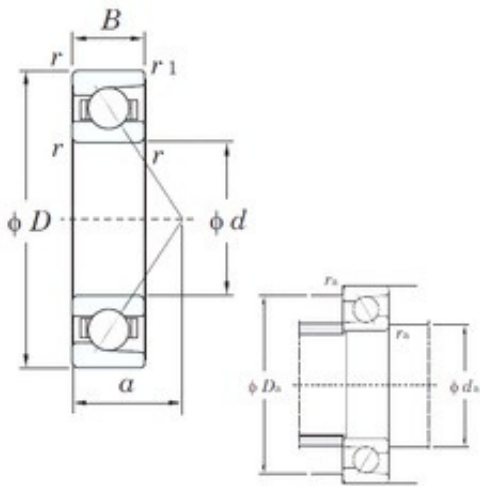

**Bearing No. 7008**

D	68 mm
d	40 mm
B	15 mm
C	15 mm
a	23.2 mm
Weight	0.210 Kg
r min.	1 mm
Da max.	62.5 mm
ra max.	1 mm
r1 min.	0.6 mm
da min.	45.5 mm
Size (mm)	40x68x15
Width (mm)	15
Bearing number	7008
Angle (?)	30 °
Bore Diameter (mm)	40
Outer Diameter (mm)	68
(Grease) Lubrication Speed	11000 r/min

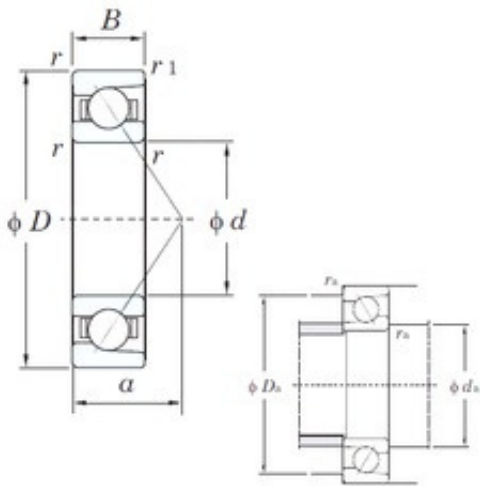

**Bearing No. 7007**

D	62 mm
d	35 mm
B	14 mm
C	14 mm
a	21.2 mm
Weight	0.170 Kg
r min.	1 mm
Da max.	56.5 mm
ra max.	1 mm
r1 min.	0.6 mm
da min.	40.5 mm
Size (mm)	35x62x14
Width (mm)	14
Bearing number	7007
Angle (?)	30 °
Bore Diameter (mm)	35
Outer Diameter (mm)	62
(Grease) Lubrication Speed	12 000 r/min

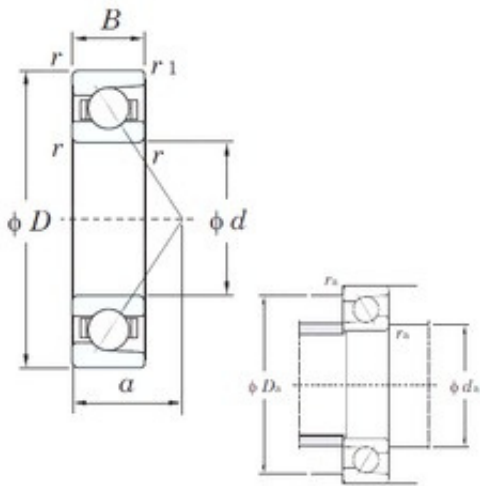

Bearing No. 7006

D	55 mm
d	30 mm
B	13 mm
C	13 mm
a	18.8 mm
Weight	0.133 Kg
r min.	1 mm
Da max.	49.5 mm
ra max.	1 mm
r1 min.	0.6 mm
da min.	35.5 mm
Size (mm)	30x55x13
Width (mm)	13
Bearing number	7006
Angle (?)	30 °
Bore Diameter (mm)	30
Outer Diameter (mm)	55
(Grease) Lubrication Speed	14 000 r/min

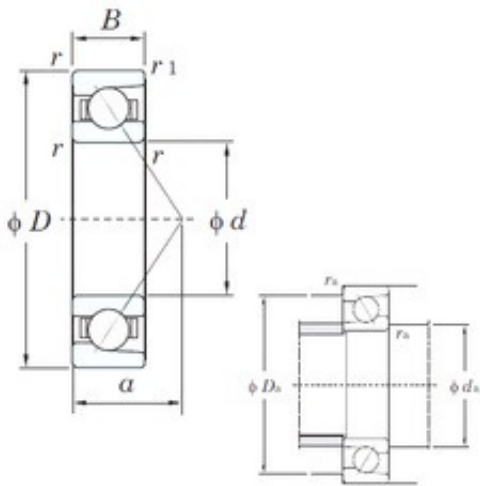

**Bearing No. 7005**

D	47 mm
d	25 mm
B	12 mm
C	12 mm
a	16.4 mm
Weight	0.091 Kg
r min.	0.6 mm
Da max.	42.5 mm
ra max.	0.6 mm
r1 min.	0.3 mm
da min.	29.5 mm
Size (mm)	25x47x12
Width (mm)	12
Bearing number	7005
Angle (?)	30 °
Bore Diameter (mm)	25
Outer Diameter (mm)	47
(Grease) Lubrication Speed	17 000 r/min

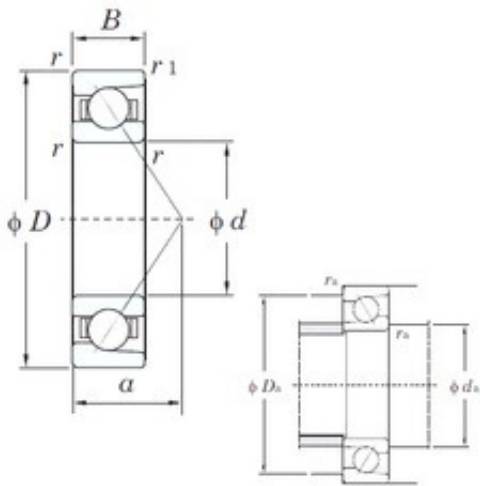

## Bearing No. 7004

D	42 mm
d	20 mm
B	12 mm
C	12 mm
a	15.1 mm
Weight	0.079 Kg
r min.	0.6 mm
Da max.	37.5 mm
ra max.	0.6 mm
r1 min.	0.3 mm
da min.	24.5 mm
Size (mm)	20x42x12
Width (mm)	12
Bearing number	7004
Angle (?)	30 °
Bore Diameter (mm)	20
Outer Diameter (mm)	42
(Grease) Lubrication Speed	19 000 r/min

# Amigo

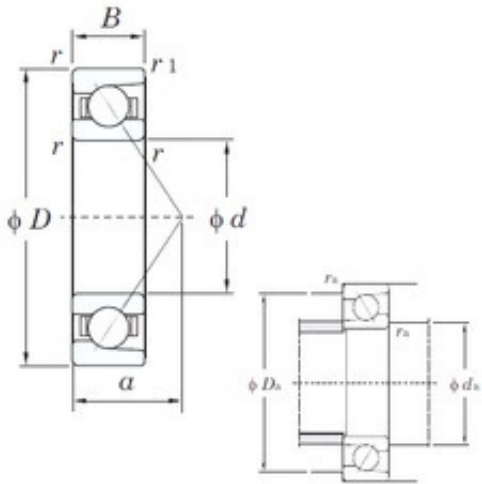

Bearing No. 7003

D	35 mm
d	17 mm
B	10 mm
C	10 mm
a	12.7 mm
Weight	0.045 Kg
r min.	0.3 mm
Da max.	32.5 mm
ra max.	0.3 mm
r1 min.	0.15 mm
da min.	19.5 mm
Size (mm)	17x35x10
Width (mm)	10
Bearing number	7003
Angle (?)	30 °
Bore Diameter (mm)	17
Outer Diameter (mm)	35
(Grease) Lubrication Speed	23000 r/min

# Amigo

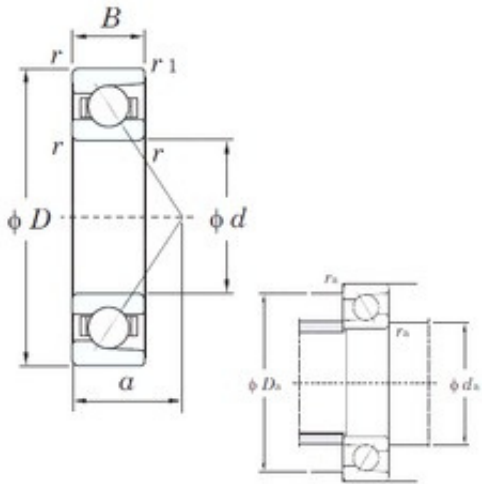

Bearing No. 7002

D	32 mm
d	15 mm
B	9 mm
C	9 mm
a	11.3 mm
Weight	0.035 Kg
r min.	0.3 mm
Da max.	29.5 mm
ra max.	0.3 mm
r1 min.	0.15 mm
da min.	17.5 mm
Size (mm)	15x32x9
Width (mm)	9
Bearing number	7002
Angle (?)	30 °
Bore Diameter (mm)	15
Outer Diameter (mm)	32
(Grease) Lubrication Speed	26000 r/min

# Amigo

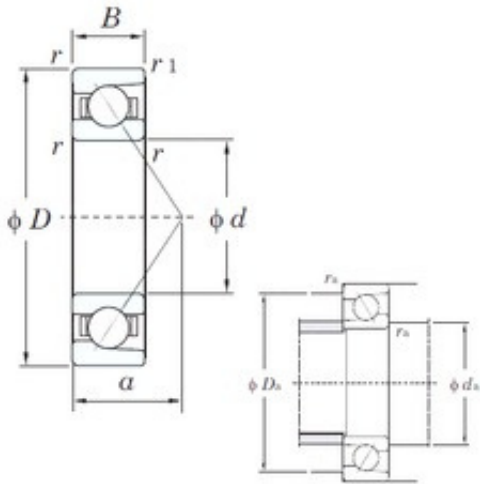

Bearing No. 7001

D	28 mm
d	12 mm
B	8 mm
C	8 mm
a	9.9 mm
Weight	0.024 Kg
r min.	0.3 mm
Da max.	25.5 mm
ra max.	0.3 mm
r1 min.	0.15 mm
da min.	14.5 mm
Size (mm)	12x28x8
Width (mm)	8
Bearing number	7001
Angle (?)	30 °
Bore Diameter (mm)	12
Outer Diameter (mm)	28
(Grease) Lubrication Speed	29000 r/min

# Amigo

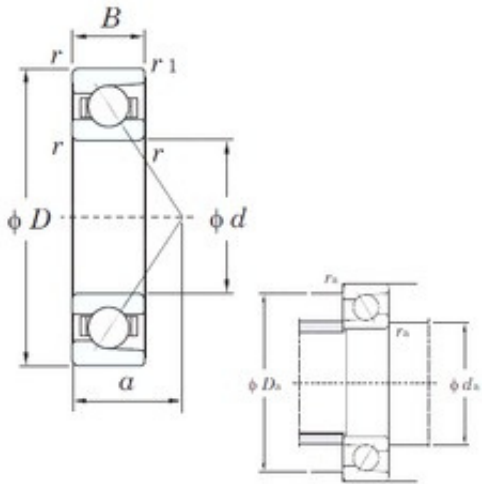

**Bearing No. 7000**

D	26 mm
d	10 mm
B	8 mm
C	8 mm
a	9.1 mm
Weight	0.021 Kg
r min.	0.3 mm
Da max.	23.5 mm
ra max.	0.3 mm
r1 min.	0.15 mm
da min.	12.5 mm
Size (mm)	10x26x8
Width (mm)	8
Bearing number	7000
Angle (?)	30 °
Bore Diameter (mm)	10
Outer Diameter (mm)	26
(Grease) Lubrication Speed	34000 r/min

### Bearing No. 7221

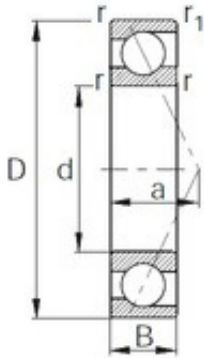

D	190 mm
d	105 mm
B	36 mm
C	36 mm
r min.	2,1 mm
Size (mm)	105x190x36
Width (mm)	36
Bearing number	7221
Angle (?)	25 °
Bore Diameter (mm)	105
Outer Diameter (mm)	190
(Grease) Lubrication Speed	3700 r/min
Basic dynamic load rating (C)	157 kN
Basic static load rating (C0)	142 kN

### Bearing No. 7220

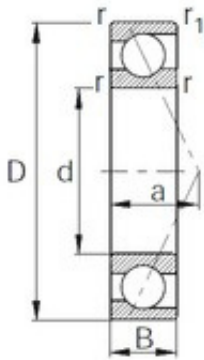

D	180 mm
d	100 mm
B	34 mm
C	34 mm
r min.	2,1 mm
Size (mm)	100x180x34
Width (mm)	34
Bearing number	7220
Angle (?)	25 °
Bore Diameter (mm)	100
Outer Diameter (mm)	180
(Grease) Lubrication Speed	3900 r/min
Basic dynamic load rating (C)	144 kN
Basic static load rating (C0)	126 kN

### Bearing No. 7219

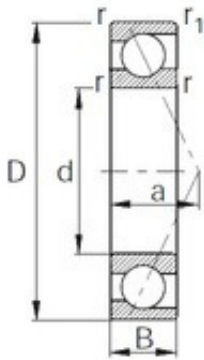

D	170 mm
d	95 mm
B	32 mm
C	32 mm
r min.	2,1 mm
Size (mm)	95x170x32
Width (mm)	32
Bearing number	7219
Angle (?)	25 °
Bore Diameter (mm)	95
Outer Diameter (mm)	170
(Grease) Lubrication Speed	4100 r/min
Basic dynamic load rating (C)	133 kN
Basic static load rating (C0)	118 kN

### Bearing No. 7218

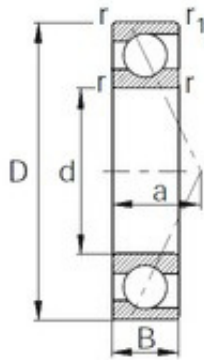

D	160 mm
d	90 mm
B	30 mm
C	30 mm
r min.	2 mm
Size (mm)	90x160x30
Width (mm)	30
Bearing number	7218
Angle (?)	25 °
Bore Diameter (mm)	90
Outer Diameter (mm)	160
(Grease) Lubrication Speed	4400 r/min
Basic dynamic load rating (C)	118 kN
Basic static load rating (C0)	103 kN

### Bearing No. 7217

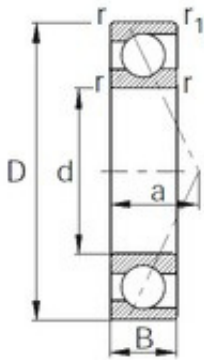

D	150 mm
d	85 mm
B	28 mm
C	28 mm
r min.	2 mm
Size (mm)	85x150x28
Width (mm)	28
Bearing number	7217
Angle (?)	25 °
Bore Diameter (mm)	85
Outer Diameter (mm)	150
(Grease) Lubrication Speed	4700 r/min
Basic dynamic load rating (C)	99,5 kN
Basic static load rating (C0)	88,5 kN

## Bearing No. 7216

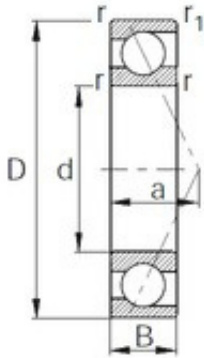

D	140 mm
d	80 mm
B	26 mm
C	26 mm
r min.	2 mm
Size (mm)	80x140x26
Width (mm)	26
Bearing number	7216
Angle (?)	25 °
Bore Diameter (mm)	80
Outer Diameter (mm)	140
(Grease) Lubrication Speed	5000 r/min
Basic dynamic load rating (C)	89 kN
Basic static load rating (C0)	76 kN

### Bearing No. 7215

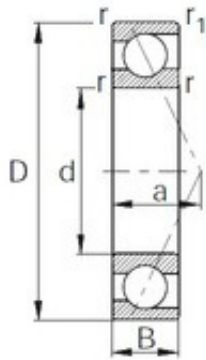

D	130 mm
d	75 mm
B	25 mm
C	25 mm
r min.	1,5 mm
Size (mm)	75x130x25
Width (mm)	25
Bearing number	7215
Angle (?)	25 °
Bore Diameter (mm)	75
Outer Diameter (mm)	130
(Grease) Lubrication Speed	5300 r/min
Basic dynamic load rating (C)	79 kN
Basic static load rating (C0)	68,5 kN

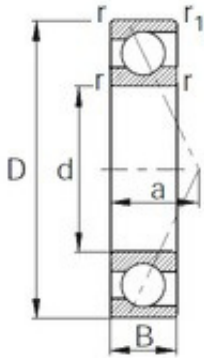

### Bearing No. 7213

D	120 mm
d	65 mm
B	23 mm
C	23 mm
r min.	1,5 mm
Size (mm)	65x120x23
Width (mm)	23
Bearing number	7213
Angle (?)	25 °
Bore Diameter (mm)	65
Outer Diameter (mm)	120
(Grease) Lubrication Speed	6100 r/min
Basic dynamic load rating (C)	70,5 kN
Basic static load rating (C0)	58 kN

### Bearing No. 7214

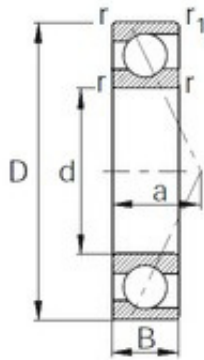

D	125 mm
d	70 mm
B	24 mm
C	24 mm
r min.	1,5 mm
Size (mm)	70x125x24
Width (mm)	24
Bearing number	7214
Angle (?)	25 °
Bore Diameter (mm)	70
Outer Diameter (mm)	125
(Grease) Lubrication Speed	5700 r/min
Basic dynamic load rating (C)	76,5 kN
Basic static load rating (C0)	63,5 kN

### Bearing No. 7212

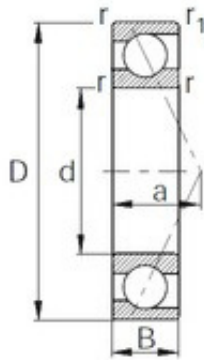

D	110 mm
d	60 mm
B	22 mm
C	22 mm
r min.	1,5 mm
Size (mm)	60x110x22
Width (mm)	22
Bearing number	7212
Angle (?)	25 °
Bore Diameter (mm)	60
Outer Diameter (mm)	110
(Grease) Lubrication Speed	6600 r/min
Basic dynamic load rating (C)	61,5 kN
Basic static load rating (C0)	49 kN

### Bearing No. 7211

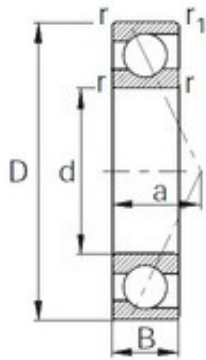

D	100 mm
d	55 mm
B	21 mm
C	21 mm
r min.	1,5 mm
Size (mm)	55x100x21
Width (mm)	21
Bearing number	7211
Angle (?)	25 °
Bore Diameter (mm)	55
Outer Diameter (mm)	100
(Grease) Lubrication Speed	7100 r/min
Basic dynamic load rating (C)	51 kN
Basic static load rating (C0)	39,5 kN

### Bearing No. 7210

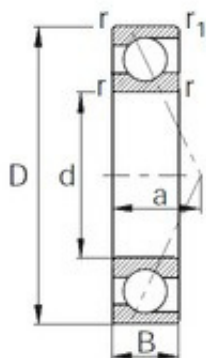

D	90 mm
d	50 mm
B	20 mm
C	20 mm
r min.	1,1 mm
Size (mm)	50x90x20
Width (mm)	20
Bearing number	7210
Angle (?)	25 °
Bore Diameter (mm)	50
Outer Diameter (mm)	90
(Grease) Lubrication Speed	7900 r/min
Basic dynamic load rating (C)	41,5 kN
Basic static load rating (C0)	31,5 kN

### Bearing No. 7209

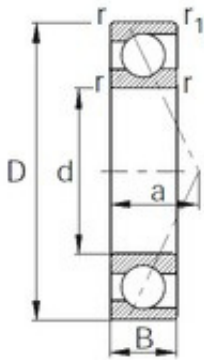

D	85 mm
d	45 mm
B	19 mm
C	19 mm
r min.	1,1 mm
Size (mm)	45x85x19
Width (mm)	19
Bearing number	7209
Angle (?)	25 °
Bore Diameter (mm)	45
Outer Diameter (mm)	85
(Grease) Lubrication Speed	8700 r/min
Basic dynamic load rating (C)	39,5 kN
Basic static load rating (C0)	28,7 kN

### Bearing No. 7208

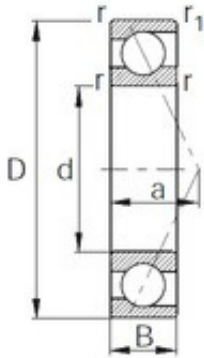

D	80 mm
d	40 mm
B	18 mm
C	18 mm
r min.	1,1 mm
Size (mm)	40x80x18
Width (mm)	18
Bearing number	7208
Angle (?)	25 °
Bore Diameter (mm)	40
Outer Diameter (mm)	80
(Grease) Lubrication Speed	6900 r/min
Basic dynamic load rating (C)	35,5 kN
Basic static load rating (C0)	25,1 kN

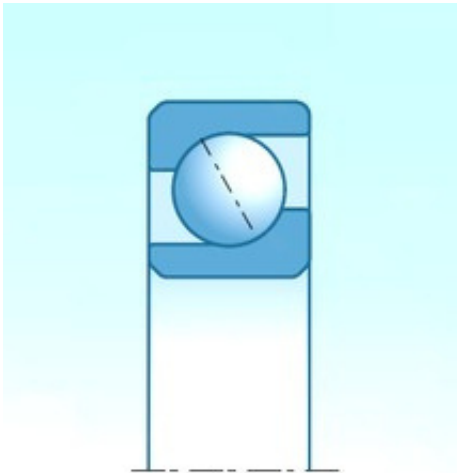

### Bearing No. 7206

D	62,000 mm
d	30,000 mm
B	16,000 mm
C	16,000 mm
Size (mm)	30x62x16
Width (mm)	16,000
Bearing number	7206
Bore Diameter (mm)	30,000
Outer Diameter (mm)	62,000

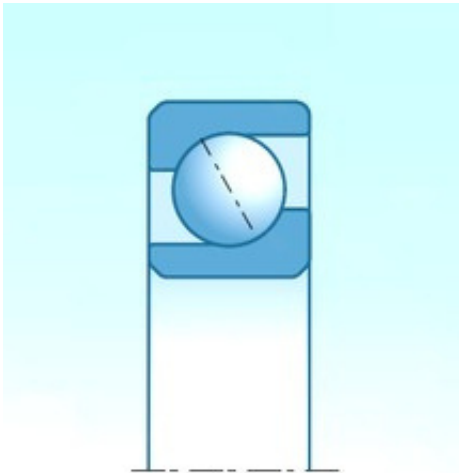

### Bearing No. 7207

D	72,000 mm
d	35,000 mm
B	17,000 mm
C	17,000 mm
Size (mm)	35x72x17
Width (mm)	17,000
Bearing number	7207
Bore Diameter (mm)	35,000
Outer Diameter (mm)	72,000

### Bearing No. 7205

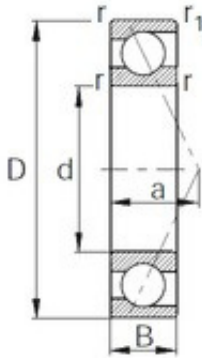

D	52 mm
d	25 mm
B	15 mm
C	15 mm
r min.	1 mm
Size (mm)	25x52x15
Width (mm)	15
Bearing number	7205
Angle (?)	25 °
Bore Diameter (mm)	25
Outer Diameter (mm)	52
(Grease) Lubrication Speed	14000 r/min
Basic dynamic load rating (C)	16,2 kN
Basic static load rating (C0)	10,3 kN

### Bearing No. 7204

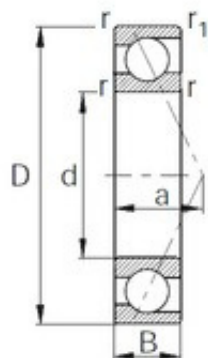

D	47 mm
d	20 mm
B	14 mm
C	14 mm
r min.	1 mm
Size (mm)	20x47x14
Width (mm)	14
Bearing number	7204
Angle (?)	25 °
Bore Diameter (mm)	20
Outer Diameter (mm)	47
(Grease) Lubrication Speed	17000 r/min
Basic dynamic load rating (C)	14,5 kN
Basic static load rating (C0)	8,4 kN

### Bearing No. 7203

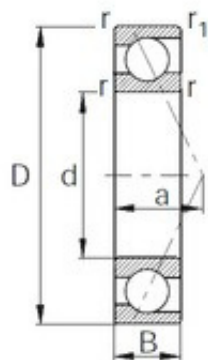

D	40 mm
d	17 mm
B	12 mm
C	12 mm
r min.	0,6 mm
Size (mm)	17x40x12
Width (mm)	12
Bearing number	7203
Angle (?)	25 °
Bore Diameter (mm)	17
Outer Diameter (mm)	40
(Grease) Lubrication Speed	19000 r/min
Basic dynamic load rating (C)	12 kN
Basic static load rating (C0)	6,6 kN

### Bearing No. 7201

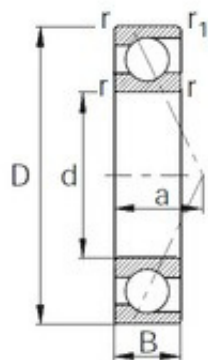

D	32 mm
d	12 mm
B	10 mm
C	10 mm
r min.	0,6 mm
Size (mm)	12x32x10
Width (mm)	10
Bearing number	7201
Angle (?)	25 °
Bore Diameter (mm)	12
Outer Diameter (mm)	32
(Grease) Lubrication Speed	25000 r/min
Basic dynamic load rating (C)	7,15 kN
Basic static load rating (C0)	3,6 kN

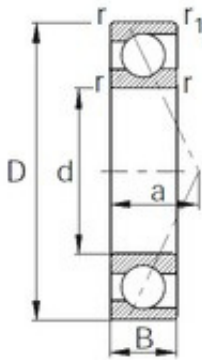

### Bearing No. 7310

D	110 mm
d	50 mm
B	27 mm
C	27 mm
r min.	2 mm
Size (mm)	50x110x27
Width (mm)	27
Bearing number	7310
Angle (?)	25 °
Bore Diameter (mm)	50
Outer Diameter (mm)	110
(Grease) Lubrication Speed	7100 r/min
Basic dynamic load rating (C)	74 kN
Basic static load rating (C0)	52 kN

## Bearing No. 7309

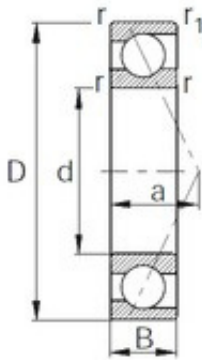

D	100 mm
d	45 mm
B	25 mm
C	25 mm
r min.	1,5 mm
Size (mm)	45x100x25
Width (mm)	25
Bearing number	7309
Angle (?)	25 °
Bore Diameter (mm)	45
Outer Diameter (mm)	100
(Grease) Lubrication Speed	7800 r/min
Basic dynamic load rating (C)	63,5 kN
Basic static load rating (C0)	43,5 kN

## Bearing No. 7308

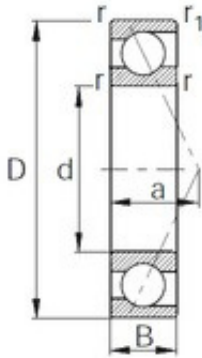

D	90 mm
d	40 mm
B	23 mm
C	23 mm
r min.	1,5 mm
Size (mm)	40x90x23
Width (mm)	23
Bearing number	7308
Angle (?)	25 °
Bore Diameter (mm)	40
Outer Diameter (mm)	90
(Grease) Lubrication Speed	8600 r/min
Basic dynamic load rating (C)	49 kN
Basic static load rating (C0)	33 kN

## Bearing No. 7306

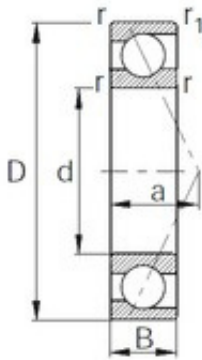

D	72 mm
d	30 mm
B	19 mm
C	19 mm
r min.	1,1 mm
Size (mm)	30x72x19
Width (mm)	19
Bearing number	7306
Angle (?)	25 °
Bore Diameter (mm)	30
Outer Diameter (mm)	72
(Grease) Lubrication Speed	11000 r/min
Basic dynamic load rating (C)	33,5 kN
Basic static load rating (C0)	22,3 kN

## Bearing No. 7307

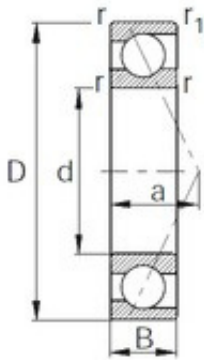

D	80 mm
d	35 mm
B	21 mm
C	21 mm
r min.	1,5 mm
Size (mm)	35x80x21
Width (mm)	21
Bearing number	7307
Angle (?)	25 °
Bore Diameter (mm)	35
Outer Diameter (mm)	80
(Grease) Lubrication Speed	9800 r/min
Basic dynamic load rating (C)	40 kN
Basic static load rating (C0)	26,3 kN

## Bearing No. 7304

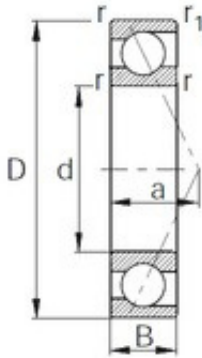

D	52 mm
d	20 mm
B	15 mm
C	15 mm
r min.	1,1 mm
Size (mm)	20x52x15
Width (mm)	15
Bearing number	7304
Angle (?)	25 °
Bore Diameter (mm)	20
Outer Diameter (mm)	52
(Grease) Lubrication Speed	16000 r/min
Basic dynamic load rating (C)	18,7 kN
Basic static load rating (C0)	10,4 kN

## Bearing No. 7305

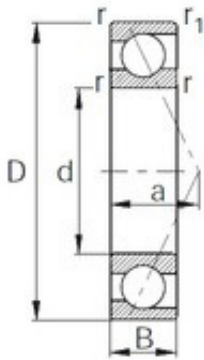

D	62 mm
d	25 mm
B	17 mm
C	17 mm
r min.	1,1 mm
Size (mm)	25x62x17
Width (mm)	17
Bearing number	7305
Angle (?)	25 °
Bore Diameter (mm)	25
Outer Diameter (mm)	62
(Grease) Lubrication Speed	13000 r/min
Basic dynamic load rating (C)	26,4 kN
Basic static load rating (C0)	15,8 kN

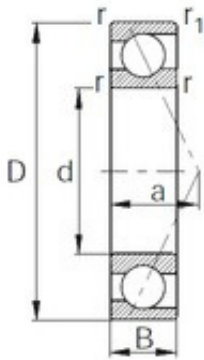

### Bearing No. 7302

D	42 mm
d	15 mm
B	13 mm
C	13 mm
r min.	1 mm
Size (mm)	15x42x13
Width (mm)	13
Bearing number	7302
Angle (?)	25 °
Bore Diameter (mm)	15
Outer Diameter (mm)	42
(Grease) Lubrication Speed	19000 r/min
Basic dynamic load rating (C)	13,5 kN
Basic static load rating (C0)	7,2 kN

## Bearing No. 7303

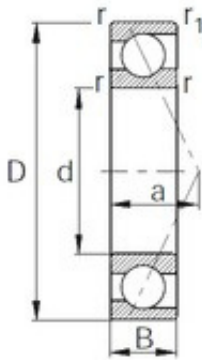

D	47 mm
d	17 mm
B	14 mm
C	14 mm
r min.	1 mm
Size (mm)	17x47x14
Width (mm)	14
Bearing number	7303
Angle (?)	25 °
Bore Diameter (mm)	17
Outer Diameter (mm)	47
(Grease) Lubrication Speed	18000 r/min
Basic dynamic load rating (C)	15,9 kN
Basic static load rating (C0)	8,65 kN

## Bearing No. 7300

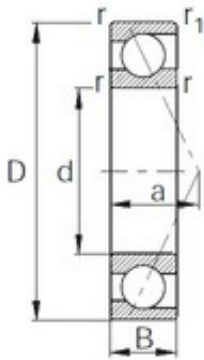

D	35 mm
d	10 mm
B	11 mm
C	11 mm
r min.	0,6 mm
Size (mm)	10x35x11
Width (mm)	11
Bearing number	7300
Angle (?)	25 °
Bore Diameter (mm)	10
Outer Diameter (mm)	35
(Grease) Lubrication Speed	26000 r/min
Basic dynamic load rating (C)	9,35 kN
Basic static load rating (C0)	4,4 kN

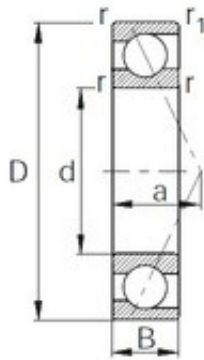

## Bearing No. 7301

D	37 mm
d	12 mm
B	12 mm
C	12 mm
r min.	1 mm
Size (mm)	12x37x12
Width (mm)	12
Bearing number	7301
Angle (?)	25 °
Bore Diameter (mm)	12
Outer Diameter (mm)	37
(Grease) Lubrication Speed	23000 r/min
Basic dynamic load rating (C)	11,2 kN
Basic static load rating (C0)	5,25 kN

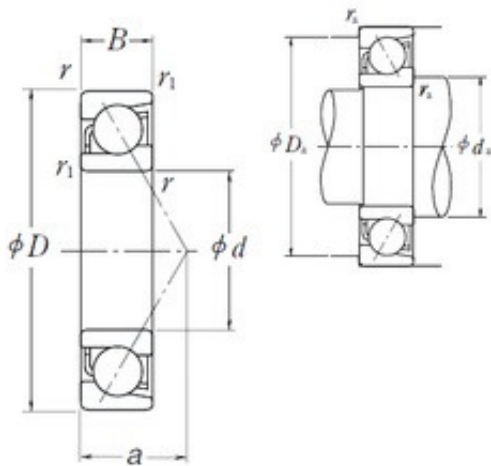

**Bearing No. 7910 C**

D	72 mm
d	50 mm
B	12 mm
C	12 mm
a	14,2 mm
r min.	0,6 mm
Weight	0,13 Kg
Da max.	67 mm
ra max.	0,6 mm
r1 min.	0,3 mm
da min.	55 mm
Size (mm)	50x72x12
Width (mm)	12
Bearing number	7910 C
Bore Diameter (mm)	50
Outer Diameter (mm)	72
(Oil) Lubrication Speed	18 000 r/min
(Grease) Lubrication Speed	13 000 r/min
Basic dynamic load rating (C)	16,9 kN
Basic static load rating (C0)	15 kN

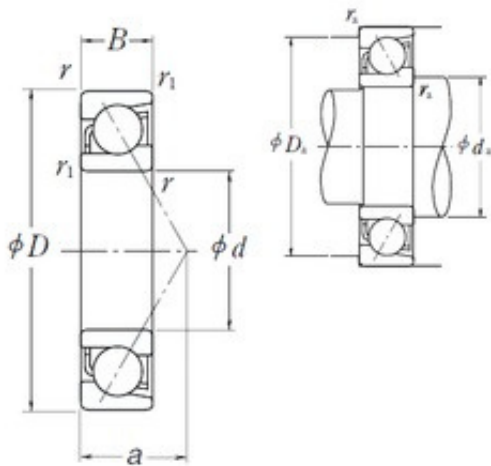

**Bearing No. 7909 C**

D	68 mm
d	45 mm
B	12 mm
C	12 mm
a	13,6 mm
r min.	0,6 mm
Weight	0,129 Kg
Da max.	63 mm
ra max.	0,6 mm
r1 min.	0,3 mm
da min.	50 mm
Size (mm)	45x68x12
Width (mm)	12
Bearing number	7909 C
Bore Diameter (mm)	45
Outer Diameter (mm)	68
(Oil) Lubrication Speed	20 000 r/min
(Grease) Lubrication Speed	14 000 r/min
Basic dynamic load rating (C)	16 kN
Basic static load rating (C0)	13,4 kN

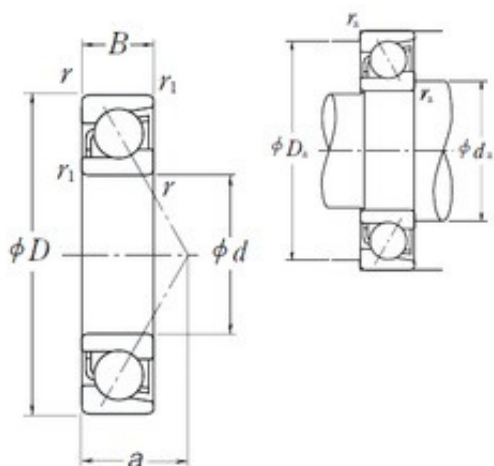

**Bearing No. 7908 C**

D	62 mm
d	40 mm
B	12 mm
C	12 mm
a	12,8 mm
r min.	0,6 mm
Weight	0,109 Kg
Da max.	57 mm
ra max.	0,6 mm
r1 min.	0,3 mm
da min.	45 mm
Size (mm)	40x62x12
Width (mm)	12
Bearing number	7908 C
Bore Diameter (mm)	40
Outer Diameter (mm)	62
(Oil) Lubrication Speed	22 000 r/min
(Grease) Lubrication Speed	16 000 r/min
Basic dynamic load rating (C)	15,1 kN
Basic static load rating (C0)	11,7 kN

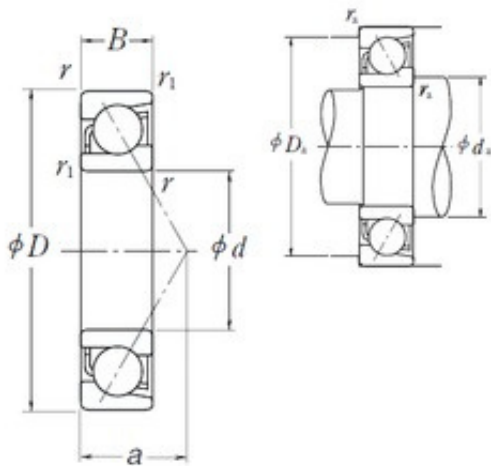

**Bearing No. 7907 C**

D	55 mm
d	35 mm
B	10 mm
C	10 mm
a	11 mm
r min.	0,6 mm
Weight	0,074 Kg
Da max.	50 mm
ra max.	0,6 mm
r1 min.	0,3 mm
da min.	40 mm
Size (mm)	35x55x10
Width (mm)	10
Bearing number	7907 C
Bore Diameter (mm)	35
Outer Diameter (mm)	55
(Oil) Lubrication Speed	24 000 r/min
(Grease) Lubrication Speed	18 000 r/min
Basic dynamic load rating (C)	12,1 kN
Basic static load rating (C0)	9,15 kN

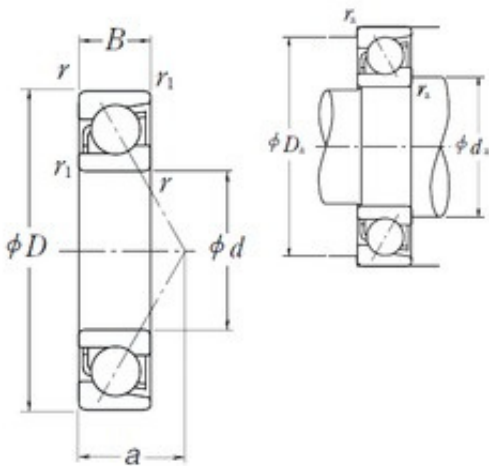

**Bearing No. 7906 C**

D	47 mm
d	30 mm
B	9 mm
C	9 mm
a	9,7 mm
r min.	0,3 mm
Weight	0,049 Kg
Da max.	44,5 mm
ra max.	0,3 mm
r1 min.	0,15 mm
da min.	32,5 mm
Size (mm)	30x47x9
Width (mm)	9
Bearing number	7906 C
Bore Diameter (mm)	30
Outer Diameter (mm)	47
(Oil) Lubrication Speed	28 000 r/min
(Grease) Lubrication Speed	22 000 r/min
Basic dynamic load rating (C)	8,3 kN
Basic static load rating (C0)	6,25 kN

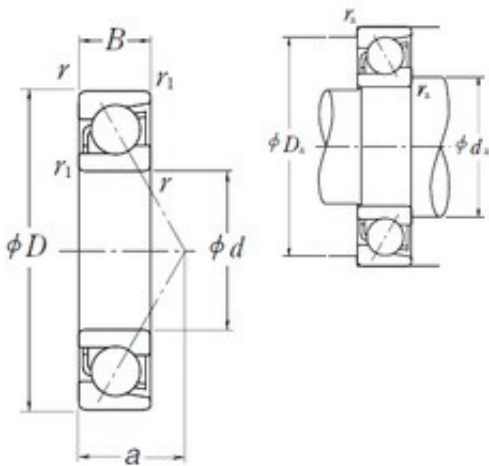

**Bearing No. 7905 C**

D	42 mm
d	25 mm
B	9 mm
C	9 mm
a	9 mm
r min.	0,3 mm
Weight	0,042 Kg
Da max.	39,5 mm
ra max.	0,3 mm
r1 min.	0,15 mm
da min.	27,5 mm
Size (mm)	25x42x9
Width (mm)	9
Bearing number	7905 C
Bore Diameter (mm)	25
Outer Diameter (mm)	42
(Oil) Lubrication Speed	34 000 r/min
(Grease) Lubrication Speed	24 000 r/min
Basic dynamic load rating (C)	7,85 kN
Basic static load rating (C0)	5,4 kN

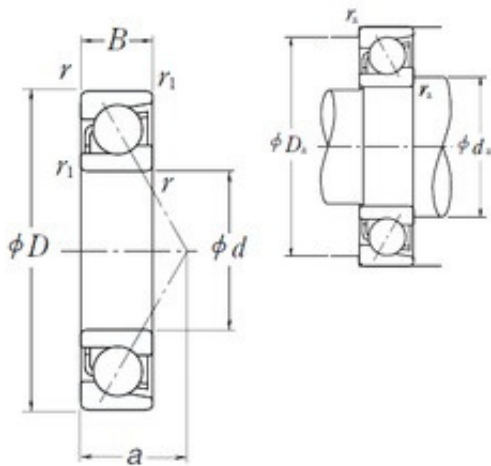

**Bearing No. 7904 C**

D	37 mm
d	20 mm
B	9 mm
C	9 mm
a	8,3 mm
r min.	0,3 mm
Weight	0,036 Kg
Da max.	34,5 mm
ra max.	0,3 mm
r1 min.	0,15 mm
da min.	22,5 mm
Size (mm)	20x37x9
Width (mm)	9
Bearing number	7904 C
Bore Diameter (mm)	20
Outer Diameter (mm)	37
(Oil) Lubrication Speed	38 000 r/min
(Grease) Lubrication Speed	28 000 r/min
Basic dynamic load rating (C)	6,95 kN
Basic static load rating (C0)	4,25 kN

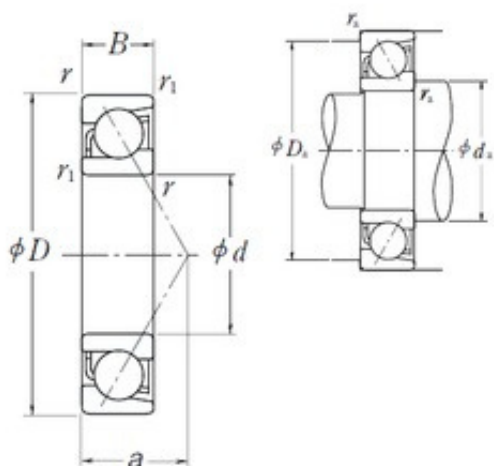

Bearing No. 7902 C

D	28 mm
d	15 mm
B	7 mm
C	7 mm
a	6,4 mm
r min.	0,3 mm
Weight	0,015 Kg
Da max.	25,5 mm
ra max.	0,3 mm
r1 min.	0,15 mm
da min.	17,5 mm
Size (mm)	15x28x7
Width (mm)	7
Bearing number	7902 C
Bore Diameter (mm)	15
Outer Diameter (mm)	28
(Oil) Lubrication Speed	53 000 r/min
(Grease) Lubrication Speed	38 000 r/min
Basic dynamic load rating (C)	4,75 kN
Basic static load rating (C0)	2,64 kN

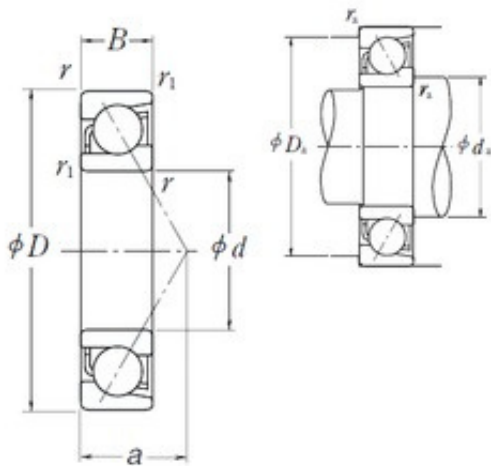

**Bearing No. 7903 C**

D	30 mm
d	17 mm
B	7 mm
C	7 mm
a	6,6 mm
r min.	0,3 mm
Weight	0,017 Kg
Da max.	27,5 mm
ra max.	0,3 mm
r1 min.	0,15 mm
da min.	19,5 mm
Size (mm)	17x30x7
Width (mm)	7
Bearing number	7903 C
Bore Diameter (mm)	17
Outer Diameter (mm)	30
(Oil) Lubrication Speed	48 000 r/min
(Grease) Lubrication Speed	34 000 r/min
Basic dynamic load rating (C)	5 kN
Basic static load rating (C0)	2,94 kN

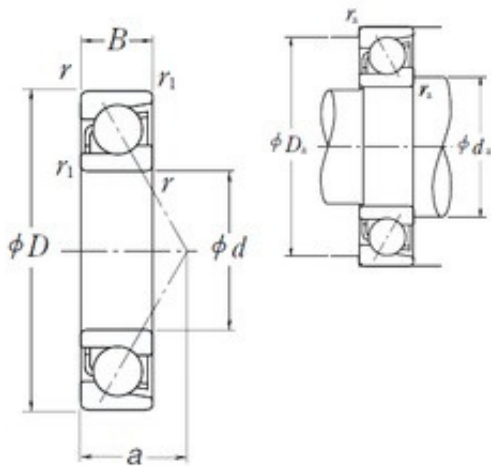

**Bearing No. 7901 C**

D	24 mm
d	12 mm
B	6 mm
C	6 mm
a	5,4 mm
r min.	0,3 mm
Weight	0,011 Kg
Da max.	21,5 mm
ra max.	0,3 mm
r1 min.	0,15 mm
da min.	14,5 mm
Size (mm)	12x24x6
Width (mm)	6
Bearing number	7901 C
Bore Diameter (mm)	12
Outer Diameter (mm)	24
(Oil) Lubrication Speed	63 000 r/min
(Grease) Lubrication Speed	45 000 r/min
Basic dynamic load rating (C)	3,35 kN
Basic static load rating (C0)	1,86 kN

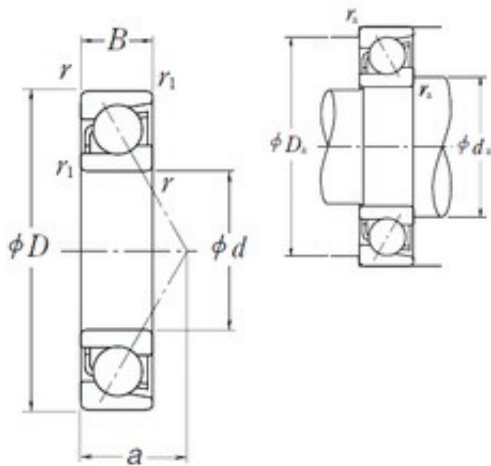

**Bearing No. 7900 C**

D	22 mm
d	10 mm
B	6 mm
C	6 mm
a	5,1 mm
r min.	0,3 mm
Weight	0,009 Kg
Da max.	19,5 mm
ra max.	0,3 mm
r1 min.	0,15 mm
da min.	12,5 mm
Size (mm)	10x22x6
Width (mm)	6
Bearing number	7900 C
Bore Diameter (mm)	10
Outer Diameter (mm)	22
(Oil) Lubrication Speed	63 000 r/min
(Grease) Lubrication Speed	48 000 r/min
Basic dynamic load rating (C)	3 kN
Basic static load rating (C0)	1,52 kN