

Bearing No. BH-810

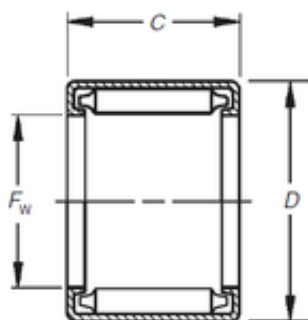

D	19,05 mm
C	15,88 mm
F _w	12,7 mm
Weight	0,015 Kg
Size (mm)	12.7x19.05x15.88
Width (mm)	15,88
Bearing number	BH-810
Bore Diameter (mm)	12,7
Outer Diameter (mm)	19,05
(Grease) Lubrication Speed	5100 r/min
Basic dynamic load rating (C)	14,4 kN
Basic static load rating (C ₀)	20,2 kN