

### Bearing No. BH-78

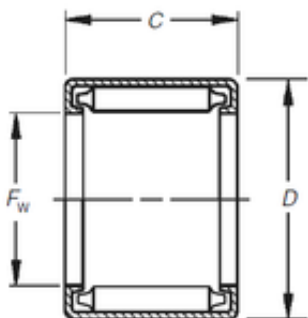

D	17,463 mm
C	12,7 mm
Fw	11,113 mm
Weight	0,01 Kg
Size (mm)	11.113x17.463x12.7
Width (mm)	12,7
Bearing number	BH-78
Bore Diameter (mm)	11,113
Outer Diameter (mm)	17,463
(Grease) Lubrication Speed	5700 r/min
Basic dynamic load rating (C)	10,3 kN
Basic static load rating (C0)	12,8 kN