

Bearing No. BH-108

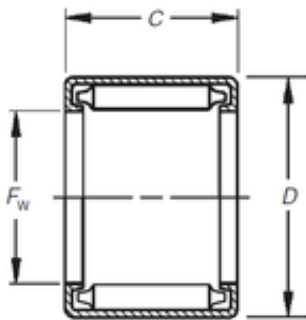

D	22,212 mm
C	12,7 mm
Fw	15,875 mm
Weight	0,014 Kg
Size (mm)	15.875x22.212x12.7
Width (mm)	12,7
Bearing number	BH-108
Bore Diameter (mm)	15,875
Outer Diameter (mm)	22,212
(Grease) Lubrication Speed	4200 r/min
Basic dynamic load rating (C)	12,7 kN
Basic static load rating (C0)	18,3 kN