

Bearing No. B-710

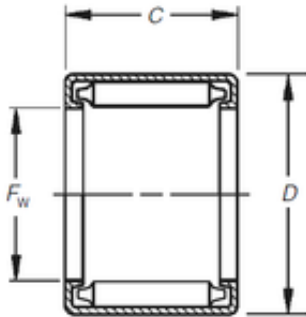

D	15,875 mm
C	15,88 mm
F _w	11,113 mm
Weight	0,01 Kg
Size (mm)	11.113x15.875x15.88
Width (mm)	15,88
Bearing number	B-710
Bore Diameter (mm)	11,113
Outer Diameter (mm)	15,875
(Grease) Lubrication Speed	4100 r/min
Basic dynamic load rating (C)	11,3 kN
Basic static load rating (C ₀)	18,7 kN