

Bearing No. B-69

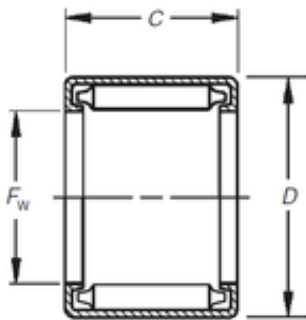

D	14,288 mm
C	14,27 mm
Fw	9,525 mm
Weight	0,007 Kg
Size (mm)	9.525x14.288x14.27
Width (mm)	14,27
Bearing number	B-69
Bore Diameter (mm)	9,525
Outer Diameter (mm)	14,288
(Grease) Lubrication Speed	4600 r/min
Basic dynamic load rating (C)	9,34 kN
Basic static load rating (C0)	13,92 kN