

Bearing No. B-67

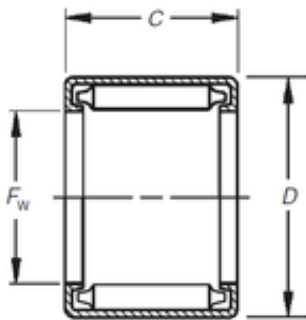

D	14,288 mm
C	11,13 mm
Fw	9,525 mm
Weight	0,006 Kg
Size (mm)	9.525x14.288x11.13
Width (mm)	11,13
Bearing number	B-67
Bore Diameter (mm)	9,525
Outer Diameter (mm)	14,288
(Grease) Lubrication Speed	4600 r/min
Basic dynamic load rating (C)	7,07 kN
Basic static load rating (C0)	9,7 kN