

### Bearing No. B-146

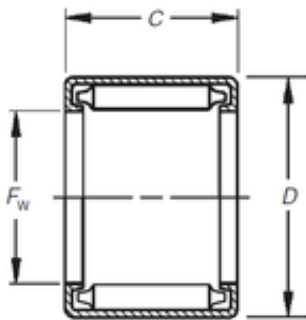

D	28,575 mm
C	9,53 mm
Fw	22,225 mm
Weight	0,014 Kg
Size (mm)	22.225x28.575x9.53
Width (mm)	9,53
Bearing number	B-146
Bore Diameter (mm)	22,225
Outer Diameter (mm)	28,575
(Grease) Lubrication Speed	3100 r/min
Basic dynamic load rating (C)	10,5 kN
Basic static load rating (C0)	15,84 kN