

Bearing No. B-126

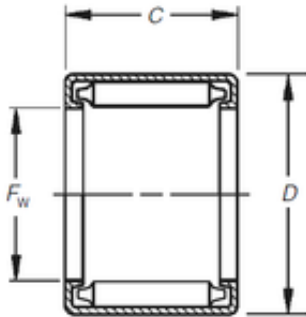

D	25,4 mm
C	9,53 mm
Fw	19,05 mm
Weight	0,012 Kg
Size (mm)	19.05x25.4x9.53
Width (mm)	9,53
Bearing number	B-126
Bore Diameter (mm)	19,05
Outer Diameter (mm)	25,4
(Grease) Lubrication Speed	3600 r/min
Basic dynamic load rating (C)	9,7 kN
Basic static load rating (C0)	13,6 kN